



CATALOGUE

PORTABLE **TEST AND MEASUREMENT** INSTRUMENTS



Measure up



About the CHAUVIN ARNOUX GROUP

Founded in Paris, France in 1893, **CHAUVIN ARNOUX** has spent the centuries since then developing its expertise in the design, manufacture and marketing of measuring instruments for professionals.

From handheld instrumentation to fixed electrical equipment and energy performance systems, and from control of the entire thermal process chain to industrial metrology, the **CHAUVIN ARNOUX** Group's offering meets every customer requirement across all the sectors (self-employed electricians, industry, government bodies, etc.).

“ CHAUVIN ARNOUX is a major player in the measurement market in France and internationally. ”

Your partner:

- energy performance
- regulatory testing
- environmental measurements
- installation supervision and sizing.

A Few Figures

- 10 subsidiaries worldwide
- 900 employees
- 6 production sites
- 6 R&D departments worldwide
- 11% of revenues invested in R&D
- Turnover of 100 million euros



Made in France
The French family company Chauvin Arnoux designs and manufactures 80 % of its products in the R&D Centres and production sites owned by the Group. Its three sites in Normandy and its site at Meyzieu, near Lyon, manufacture printed circuit boards, mechanical parts and temperature sensors, while also handling the assembly of measuring instruments for all the Group's brands.



4 expert measurement companies in one Group



Portable test and measurement instrumentation



Metering, measurement and energy performance











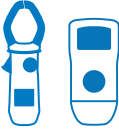

Temperatures in industrial processes



Metrology and regulatory testing

CONTENTS

	MULTIMETERS <ul style="list-style-type: none">• Clamp multimeters 4• Multimeters 6
	TESTERS <ul style="list-style-type: none">• LED voltage tester 8• Digital testers 8
	PHYSICAL MEASUREMENTS <ul style="list-style-type: none">• Contact thermometers 9• Thermo-hygrometers 10• Measurement of CO₂ / Temperature / Humidity 10• Luxmeters 11• Thermo-anemometers 11
	TESTING AND ELECTRICAL SAFETY <ul style="list-style-type: none">• Assessing the safety of installations 12• Electrical installation testers 13• Insulation testers 14• Earth and resistivity testers 18• Earth and resistivity kit 18• Earth and resistivity testers with pylon earth measurement adapter 19• Earth clamps 20• Cable and metal duct detector 21• Micro-ohmmeters 22• Ratiometer 23
	POWER, ENERGY, DISTURBANCES <ul style="list-style-type: none">• Three-phase network and power analysers 24• Power and energy loggers 26
	OSCILLOSCOPES <ul style="list-style-type: none">• Portable oscilloscopes 28
	CURRENT MEASUREMENTS <ul style="list-style-type: none">• AC and AC/DC current measurements 30• Measurements with oscilloscopes 31• Ammeters with flexible sensors 32• Flexible current sensors 33
	DATA PROCESSING SOFTWARE <ul style="list-style-type: none">• DataView software 34
	ACCESSORIES <ul style="list-style-type: none">• Measurement leads, protection and transport accessories 34
	ENVIRONMENTAL MEASUREMENTS <ul style="list-style-type: none">• Thermal cameras 36

Find all our news and documentation at
WWW.CHAUVIN-ARNOUX.COM



MULTIMETERS

Digital multimeter clamps

1000 V
CAT IV

IP
54

True
InRush



**3 series of clamps for 3 measurement ranges:
discover our range and choose your clamp!**

F200 600 A _{AC} / 900 A _{DC} Clamping Ø 34 mm	F400 1,000 A _{AC} / 1,500 A _{DC} Clamping Ø 48 mm	F600 2,000 A _{AC} / 3,000 A _{DC} Clamping Ø 60 mm
---	---	---

**Voltage up to 1,000 V + Resistance, audible continuity
+ True *InRush***







F201 / F401 / F601	F203 / F403 / F603	F205 / F405 / F605	F407 / F607
AC applications	AC or DC applications	Mixed AC+DC applications + testing and maintenance	Mixed AC+DC applications + analysis and verification
Everything you need for installations and equipment powered by the mains supply	DC current Temperature Adapter function ΔREL	Power THD ΔREL Min/Max/Peak Phase rotation	Power Harmonics Ripple Recording PC software

True *InRush*
A CHAUVIN ARNOUX innovation

Thanks to the TrueInRush function, the clamp automatically determines the type of signal and the level of current in the installation and then adapts the algorithm and measurement procedure to capture the next current surge.

	F201	F203	F205	F401	F403	F405	F407	F603	F605	F607	
Reference	P01120921	P01120923	P01120925	P01120941	P01120943	P01120945	P01120947	P01120963	P01120965	P01120967	
Specifications											
Clamping diameter	Ø 34 mm			Ø 48 mm			Ø 60 mm				
Display	LCD Backlit LCD			Backlit LCD			Backlit LCD				
Resolution	6,000 counts			10,000 counts			10,000 counts				
Number of values displayed	1			1			3		1		3
Type of acquisition	TRMS [AC]	TRMS [AC]/DC	TRMS [AC, AC+DC]/DC	TRMS [AC]	TRMS [AC]/DC	TRMS [AC, AC+DC]/DC		TRMS [AC]/DC	TRMS [AC, AC+DC]/DC		
Autorange function	Yes			Yes			Yes				
Automatic AC/DC detection	Yes			Yes			Yes				
AAC	0.15 to 600 A (900 A peak)			1,000 A			2,000 A (3,000 A peak)				
ADC	0.15 to 900 A peak			1,500 A peak			3,000 A				
AAC+DC	0.15 to 600 A (900 A peak)			1,000 A (1,500 A peak)			2,000 A (3,000 A peak)				
Best accuracy	1 % R + 3 counts			1 % R + 3 counts			1 % R + 3 counts				
VAC	0.15 to 1,000 A (1,400 A peak)			1,000 V			1,000 V				
VDC	0.15 to 1,400 V			1,400 V			1,400 V				
VAC+DC	0.15 to 1,000 V (1,400 V peak)			1,000 A (1,400 A peak)			1,000 A (1,400 A peak)				
Best accuracy	1 % R + 3 cts			1 % R + 3 counts			1 % R + 3 counts				
Frequency of V / I	Yes / Yes			Yes / Yes			Yes / Yes				
Resistance	60 kΩ			100 kΩ			100 kΩ				
Audible continuity	Adjustable from 1 Ω to 599 Ω			Adjustable from 1 Ω to 999 Ω			Adjustable from 1 Ω to 999 Ω				
Diode test (semi-conductor junction)	Yes			Yes			Yes				
Adapter	Yes			Yes			Yes				
Single-phase and total three-phase power values	Yes			Yes			Yes				
temperature (K type)	°C: -60.0 to +1,000.0 °C / °F: -76.0 to +1,832 °F			°C: -60.0 to +1,000.0 °C / °F: -76.0 to +1,832 °F			°C: -60.0 to 1,000.0 °C / °F: -76.0 to +1,832 °F				
active (W)	Yes			Yes			Yes				
reactive Var (Q1)	Yes			Yes			Yes				
apparent (VA)	Yes			Yes			Yes				
FP / DPF	Yes / No			Yes / -			Yes / Yes		Yes / -		Yes / Yes
Harmonic analysis THD _r / THD _v	Yes / Yes			Yes / Yes			Yes / Yes				
Frequency analysis				25th order			25th order				
Phase rotation (2-wire method)	Yes			Yes			Yes				
Functions											
Overcurrent measurement	Yes			Yes			Yes				
Motor Inrush	Yes			Yes			Yes				
Load evolution (TrueInrush)	Yes			Yes			Yes				
Hold	Yes			Yes			Yes				
Min / MAX	Yes			Yes			Yes				
Peak+ / Peak-	Yes			Yes			Yes		Yes		Yes
RELative ΔX	Yes			Yes			Yes				
Differential ΔX / X(%)	Yes			Yes			Yes				
Auto Power Off	Yes			Yes			Yes				
Data recording				Yes			Yes				
Communication interface				Bluetooth			Bluetooth				
Electrical safety according to IEC 61010	600V CAT IV			1,000 V CAT IV - 1,000 V CAT III			1,000 V CAT IV - 1,000 V CAT III				
Power supply	1 x 9 V LF22			4 x 1.5 V AA			4 x 1.5 V AA				
Dimensions / Weight	78 x 222 x 42 mm / 340 g			92 x 272 x 41 mm / 600 g			111 x 296 x 41 mm / 640 g				
Warranty				3 years							

State at delivery

	F201 / F203	F401 / F403 / F601 / F603	F205 / F405 / F605	F407 / F607
 1 set of PVC cables (black/red) with built-in test probes Ø 4 mm isolated elbowed male banana plug	x1			
 1 set of PVC cables (black/red) Ø 4 mm isolated elbowed male banana plug Ø 4 mm isolated straight male banana plug		x1	x1	x1
 2 test probes (black/red) Ø 4 mm isolated female plug		x1	x1	x1
 1 black safety crocodile clip			x1	x2
 1 wire thermocouple with integrated Ø 4 mm isolated banana connections with 19 mm spacing	x1	x1		
 1 x 9 V 6LR61 battery (F200 series) 4 x 1.5V LR03 batteries (F400/F600 series)	x1	x1	x1	x1
 Multifix bag 120 x 245 x 60 mm (F200 series) 120 x 320 x 60 mm (F400/F600 series)	x1	x1	x1	x1



MULTIMETERS

TRMS AC, DC and AC+DC digital multimeters

Versatility for use in the field

600 V
CAT IV

IP
54



	MTX 203	C.A 5273	C.A 5275	C.A 5277	
Reference	MTX203-Z	P01196773	P01196775	P01196777	
Display	6,000 cts	2 x 6,000 counts, backlit			
Bargraph	No	61 + 2 elements, bi-mode (full scale / central zero)			
Acquisition	TRMS AC	TRMS AC /DC	TRMS AC / DC / AC+DC		
Measurement rate	2 meas./second	5 measurements / second			
Autorange / Deactivatable		Yes / Yes			
Automatic AC /DC detection	No	Yes	No		
V_{DC}	Ranges	6 V / 60 V / 600 V	600 mV / 6 V / 60 V / 600 V / 1,000 V	60 mV / 600 mV / 6 V / 60 V / 600 V / 1,000 V	
	Typical accuracy	0.2 % + 2 cts		0.09 % + 2 cts	
	Resolution	0.01 V to 1 V	0.1 mV to 1 V	0.01 mV to 1 V	
V_{AC}	Ranges	6 V / 60 V / 600 V / 750 V	600 mV / 6 V / 60 V / 600 V / 1,000 V	60 mV / 600 mV / 6 V / 60 V / 600 V / 1,000 V	
	Resolution	0.001V to 1V	0.1 mV to 1 V	0.01 mV to 1 V	
	Bandwidth	1 kHz	40 Hz to 3 kHz	40 Hz to 10 kHz	
V_{Low AC} (Low impedance + Low-pass filter)	Ranges	6 V / 60 V / 600 V / 750 V	600 mV / 6 V / 60 V / 600 V / 1000 V		
	Resolution	0.001V to 1V	0.1 mV to 1 V		
V_{AC + DC}	Ranges		60 mV / 600 mV / 6 V / 60 V / 600 V / 1,000 V		
	Resolution		0.01 mV to 1 V		
A_{DC}	Ranges	600 µA / 6 mA / 60 mA / 600 mA / 6 A / 10 A	6 A / 10 A (20 A / 30 s)	6,000 µA / 60 mA / 600 mA / 6 A / 10 A (20 A / 30 s)	
	Resolution	0.1 µA to 0,01A	0.001 A to 0,01 A	1 µA to 0.01 A	
A_{AC}	Ranges	600 µA / 6 mA / 60 mA / 600 mA / 6 A / 10 A	6 A / 10 A	6,000 µA / 60 mA / 600 mA / 6 A / 10 A (20 A / 30 s)	
	Resolution	0.1 µA to 0.01A	0.001 A to 0.01 A	1 µA to 0.01 A	
A_{AC + DC}	Ranges			6,000 µA / 60 mA / 600 mA / 6 A / 10 A (20 A / 30 s)	
	Resolution			1 µA to 0.01 A	
Resistance	Ranges	600 / 6k / 60k / 600k / 6M / 60 MΩ	600 Ω / 6,000 Ω / 60 kΩ / 600 kΩ / 6 MΩ / 60 MΩ		
	Resolution	0.1 Ω to 0.01 MΩ	0.1 Ω to 0.1 MΩ		
Audible continuity		Yes			
Diode test		Yes			
Hz	Ranges	No	600 Hz / 6 kHz / 50 kHz		
	Resolution		0.1 Hz to 10 Hz		
Capacitance	Ranges	1nF/10nF/100nF/10µF/100µF/1mF/10mF/100mF	6 nF / 60 nF / 600 nF / 6 µF / 60 µF / 600 µF / 6 mF / 60 mF		
	Resolution	0.001 nF to 10 µF	0.001 nF (1 pF) to 10 µF		
Temperature	Ranges	-55°C to +1,200°C	-59.6 °C to +1,200 °C -4 °F to +2,192 °F	-59.6 °C to +1,200 °C -4 °F to +2,192 °F	
	Resolution	0.1 °C	0.1° to 1 °	0.1° to 1 °	
Hold	Yes		Yes		
Min / Max (100 ms)	No		Yes		
Peak+ / Peak- (1 ms)			No	Yes	
Differential measurement (ΔX) / Relative (ΔX/X%)			No	Yes	
Automatic power-off		Yes (deactivatable)			
Power supply	2 x 1.5 V AA		1 x 9 V		
Dimensions / weight	170 x 80 x 50 mm / 320g		90 x 190 x 45 / 400 g		

State at delivery

MTX 203 : 1 shockproof sheath, 1.5 m straight lead / red CAT III 600 V test probe, 1.5 m straight lead / black CAT III 600 V test probe, 1 flexible K thermocouple with Ø 4 mm adapter, 1 user's manual on paper, 2 x 1.5 V AA batteries.

C.A 5270 multimeter delivered with a set of banana leads, a set of test probes, a 9 V battery and a CD containing the user's manual and the startup guide.

C.A 5273 : plus a K temperature sensor

C.A 5275 : plus a bag and a Multifix adapter

C.A 5277 : plus a K thermocouple temperature sensor, a bag and a Multifix adapter

Accessories

MULTIFIX accessory.....	P01102100Z
SHT40KV voltage probe.....	P01102097
Adapter + TK temperature probe	P01102107Z
CMS clamp	HX0064
Set of 2 magnetized test probes	P01103058Z
Fuse F1000 V 10 A, 10 x 38 mm (x 5).....	P01297096
F1000 V 0.63 A, 6.3 x 32 mm (x 5).....	P01297098

ASYC IV digital multimeters range

The 1st multimeters with graphical colour screens!



	MTX 3290	MTX 3291 *	MTX 3292	MTX 3293
Reference	MTX3290	MTX3291	MTX3292 MTX3292-BT Bluetooth	MTX3293 MTX3293-BT Bluetooth
DC, AC and AC+DC voltages (range)	60 mV to 600 V		100 mV to 1,000 V	
DC accuracy	0.3%	0.05 %	0.03 %	0.02 %
AC and AC+DC bandwidth	20 kHz	100 kHz	100 kHz	200 kHz
DC, AC and AC+DC current (range)	600 µA to 10 A /20 A (30 s max)*		1000 µA to 10 A /20 A (30 s max)	
DC accuracy	1.2%	0.08 %	0.01 %	
Frequency (range)	60 Hz to 600 kHz		10 Hz to 5 MHz	
Resistance (range)	600 Ω to 60 MΩ		100 Ω to 100 MΩ	
Audible continuity	600 Ω SIGNAL < 30 Ω ±5 Ω < 5 V		1,000 Ω SIGNAL < 20 Ω < 3.5 V	
Test diode	3 V with 1 mV resolution		Diode 0 -2.6 V < 1 mA + Zener diode or LED 0-20 V < 11 mA	
Capacitance (range)	6 nF to 60 mF		1 nF to 10 mF	
Temperature Pt100/1000	-200 °C to 800 °C			
Temperature TK/TJ	-40 to +1,200 °C			
Other functions				
Monitoring	Time/date-stamped MAX/MIN / AVG or PEAK ±, on all the main positions		Time/date-stamped SURV MAX / MIN / AVG or PEAK ± on all the main positions	
REL	REL relative value + secondary display of measured reference value*		REF-delta unit relative value or on 3 displays + main measurement	
PWM filter	300 Hz low-pass, 4th order for measurement on asynchronous motor variable speed drive			
Clamp voltage output function with direct reading	Integration of ratio 1/1, 1/10, 1/100, 1/1000 mV/A		Settable ratio Ax	
Secondary functions or measurements	dBm and resistive power in VA, duty cycle +/-, and pulse width*		3 measurements + main measurement	
SPEC	Display of measurement tolerance +Smin+Smax			
GRAPH	Trend of main measurement < 60 s + Zoom + Cursor			
Central zero	Selectable or automatic* bargraph for VDC and I DC		Automatic trend bargraph	
Measurement storage			1,000	6,500
General specifications				
Type of display	LCD with backlighting*, digit height 14 mm 60, 000-count* or 6, 000-count double display		Graphical colour display (70 x 52) with backlighting, 4 x 100,000-count displays with black background	
PC interfaces	Optical USB connector and SX-DMM software		Optical USB connector or Bluetooth (option) - SX-DMM software	
Power supply	4 AA batteries or Ni-MH rechargeable batteries		Charger or 4 AA batteries or Ni-MH rechargeable batteries	
Safety	Safety as per IEC61010-1 1000 V CAT III / 600 V CAT IV* or 600V CAT III / 300V CAT IV - Safety as per IEC 61010-2-033		Safety as per IEC61010-1 1000 V CAT III / 600 V CAT IV Safety as per IEC 61010-2-033	
Environment	Storage -20 °C to +70 °C – Operation -10 °C to +55 °C		Storage -20 °C to +70 °C – Operation 0 °C to +40 °C	
Mechanical specifications	Dimensions (L x W x H): 196 x 90 x 47.1 mm – Weight: 570 g			
Warranty	3 years			

State at delivery

- **MTX 3290:** delivered with 4 x 1.5 V alkaline batteries, 1.5 m red straight/straight cable, 1.5 m black straight/straight cable, red CAT IV 1 kV test probe, black CAT IV 1 kV test probe, 1 user's manual on CD and 1 startup guide on paper
- **MTX 3291:** delivered with 4 x 1.5 V alkaline batteries, 1.5 m red straight/straight cable, 1.5 m black straight/straight cable, red CAT IV 1 kV test probe, black CAT IV 1 kV test probe, 1 user's manual on CD and 1 startup guide on paper, plus a bag, a USB cable, an SCPI remote programming manual and the SX-DMM software
- **MTX 3292 and MTX 3293:** delivered with a bag, 4 x 2400mAh 1.5V NI-MH rechargeable batteries, a charger, a red 1.5m straight/straight cable, a black 1.5m straight/straight cable, 1 red CAT IV 1 kV test probe, 1 black CAT IV 1kV test probe, 1 USB optical cable + SX-DMM software, user's manual on CD, SCPI programming commands manual and startup guide on paper

Accessories

- Graphical colour MTX 329X calibration software > **HX0059B**
- Kit of 4 Ni-MH batteries > **HX0051B**
- MTX 328X and MTX 329X external charger (4 batteries included) . . . > **HX0053B**
- MTX DMM digital multimeter transport kit > **HX0052B**
- Graphical colour DMM transport kit > **HX0052C**
- MTX 3290 and MTX 3291 calibration software > **P01196770**





TESTERS



LED voltage tester

600 V
CAT III

IP
54

	TX 01
Reference	TX0001-Z
Voltage test	12 V to 690 V (7 diodes)
Audible alarm	U > 50 V
Phase identification	Flashing "Ph" diode if U > 100 V~
Operating frequency	DC ... 400 Hz
Polarity test	"+" and "-" diodes
Audible continuity	Yes
Resistance	2 kΩ to 300 kΩ (3 diodes)
Power supply	1 x 9 V 6F22
Electrical safety	600 V CAT III
Dimensions / weight	193 x 47 x 36 mm / 170 g
Other	1.2 m built-in cable with Ø 2 mm test probe + removable Ø 2 mm test probe

State at delivery

TX0001-Z :

delivered with a removable test probe, a 9 V battery and a user's manual

Replacement parts

Red test probes P01103061Z

Digital testers



600 V
CAT III

IP
54

	C.A 755	C.A 757
Reference	P01191755	P01191757
Current testing		
Measurement range via current sensor	flexible	500 mA to 300 A (2 ranges)
Resolution		0.01 A to 0.1 A
DC voltage		
Measurement range	3 mV to 1,000 V – 4 ranges	
Resolution	1 mV to 1 V	
AC voltage		
Measurement range	100 mV to 1,000 V – 4 ranges	
Resolution	1 mV to 1 V	
Operating frequency	DC and 50/60 Hz	
Impedance	10 MΩ	
Non-contact voltage detection	230 V 50/60 Hz at a distance of approx. 5 cm	
Audible continuity test	R ≤ 30 Ω	
Resistance testing		
Measurement range	0,3 Ω to 30 MΩ – 6 ranges	
Resolution	de 0,1 Ω à 0,01 MΩ	
Capacitance testing		
Measurement range	400 pF to 30 mF	
Resolution	0.001 nF to 0.01 mF	
Standards	600 V CAT III, IEC 61010-1, IEC 61010-031, IEC 61010-032, IEC 61010-033	
Power supply	2 x 1.5 V LR03 batteries	
Battery life	100 hours with alkaline batteries – Automatic standby mode after 10 minutes	
Dimensions / weight	180 x 52 x 45 mm / 200 g	

State at delivery

- **C.A 755** delivered with 1 set of CAT III / IV fine-tipped test probes (red/black), 2 x 1.5 V LR03 alkaline batteries
- **C.A 757** delivered with 1 set of CAT III / IV fine-tipped test probes (red/black), 2 x 1.5 V LR03 alkaline batteries, 1 MiniFlex® sensor (loop length 250 mm), 1 Velcro strap

Accessories / replacement parts for C.A 745 N & C.A 755 / C.A 757

CAT III/IV red/black test probes.....	P01102152Z
Ø 2 mm CAT II red/black test probes.....	P01102153Z
Ø 4 mm CAT II red/black test probes.....	P01102154Z
C.A 753 adapter for 2P+E sockets.....	P01191748Z
Velcro strap x 5.....	P01102113
1.5 V LR3/AAA alkaline battery(x 1).....	P01296032
Bag compatible with MultiFix accessories, 120 x 200 x 60.....	P01298074
MultiFix mounting accessory	P01102100Z
MA101-250 current sensor for C.A 757	P01120591



PHYSICAL MEASUREMENTS

Logger contact thermometers

- > J, K, T, N, E, R and S thermocouples (C.A 1821 & C.A 1822)
- > Pt100 and Pt1000 resistive probes (C.A 1823)
- > Compact and magnetized for fixed or portable use
- > Can record up to 1 million points



	C.A 1821 P01654821	C.A 1822 P01654822	C.A 1823 P01654823
Reference			
Sensor	J, K, T, N, E, R, S		Pt 100, Pt 1000
No. of inputs	1	2	1
Range	-250 °C to 1,767 °C		-100 °C to 400 °C
Resolution	$\theta < 1,000 \text{ °C}$: 0.1 °C and $\theta \geq 1,000 \text{ °C}$: 1 °C		0.1 °C
Accuracy	$\pm (0.1 \% R + 0.6 \text{ °C})$		$\pm (0.4 \% R + 0.3 \text{ °C})$
Functions	Min., Max., HOLD, Alarms		
Recording	Manual start and stop on the product - Programmed recording		
Alarms	Visual alert if the threshold definable via Data Logger Transfer is overrun Recording can be triggered on the alarm threshold		
Battery life	1,000 hrs (portable mode) or 800 hrs (for the C.A 1823) / 3 years when recording (measurement base: 15 minutes)		
Protection	IP54		
Mounting	Casing equipped with a magnet, a wall-mount system and a slot for suspending the product. Compatible with the Multifix accessory.		
Connections	C.A 1821 and C.A 1822: compensated miniature female - C.A 1823: 3-point flat connector		
Dimensions / weight	150 x 72 x 32 mm / 260 g with batteries		

State at delivery

Products delivered with carrying bag, batteries, 1 USB cable, 1 measurement report and quick startup guide (complete user's manual and Data Logger Transfer software available from the Chauvin Arnoux website)



Accessories and replacement parts

Handle for CK extension.....	P03652912
Connector for K thermocouple	P03652925
Temperature sensors for C.A 1800	voir page 34
Shockproof sheath + Multifix	P01654252
Multifix.....	P01102100Z
Mains adapter	P01651023
Carrying bag.....	P01298075
Metal case.....	P01298071
Dataview software.....	P01102095
BLE / USB Bluetooth modem for PC	P01654253
4 x NiMH AA/LR6 batteries + Charger	HX0053

Data Logger Transfer, the software for analysing your data

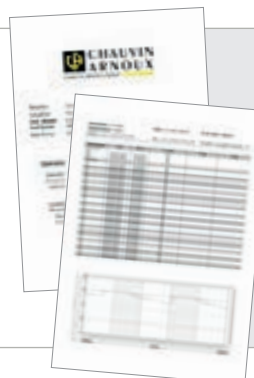

> Automatic report generation



Exportable in Word format

This simplifies editing and archiving.



PHYSICAL MEASUREMENTS

Thermo-hygrometers

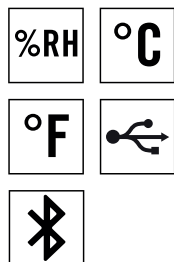

	C.A 1246
Reference	P01654246
Relative Humidity range	3.0 to 98.0 %RH
Relative Humidity accuracy	10 to 90 %RH: ± (2 %RH ± 1 ct) outside that range: ± (4 %RH ± 1 ct)
Temperature range	- 10.0 to +60.0°C
Temperature accuracy	10 to 40°C: ± (0.5°C ± 1 ct) outside that range: ± (0.032 x (T-25) ± 1 ct) / T= temperature in °C
Dew point range and accuracy	Dew point: - 20.0 to +60.0 °Ctd Accuracy: 1.5°C
Functions	Min., Max., HOLD, Alarms
Recording	Manual start/stop on the product Programmed recording
Alarms	Visual alert when threshold definable via Data Logger Transfer is overrun Recording can be triggered on the alarm threshold
Battery life	1,000 hrs (portable mode) / 3 years when recording (measurements every 15 minutes)
Ingress protection	IP54
Mounting	Casing equipped with a magnet, a wall-mount system and a slot for suspending the product. Compatible with the Multifix accessory.
Dimensions / weight	187 x 72 x 32 mm / 260 g

State at delivery

C.A 1246, delivered with carry bag, batteries, USB cable, measurement report and quick startup guide (complete manual and Data Logger Transfer software available from the Chauvin Arnoux website)



Accessories and replacement parts



75%RH salt cartridge	P01156401
33%RH salt cartridge	P01156402
Shockproof sheath + Multifix	P01654252
Multifix	P01102100Z
Mains adapter	P01651023
Carrying bag	P01298075
Metal case	P01298071
Dataview software	P01102095
Bluetooth BLE / USB modem for PC	P01654253
4 x NiMH AA/LR6 batteries + Charger	HX0053

CO₂, Temperature and Humidity Logger



	CO₂	Temperature	Humidity
Measurement range	0 to 5,000 ppm	-10°C to +60°C	5 to 95% RH
Accuracy	± 50 ppm ±3% R	±0.5°C	± 2% RH
Resolution	1 ppm	0.1° C	0.1% RH



	C.A 1510	C.A 1510 black
Reference	P01651011	P01651010
Recording intervals	Customizable from 1 minute to 2 hours	
Storage	More than 1 million points	
Buzzer and units	Yes / °C or °F	
Backlighting / Hold / Min Max	Yes	
Dimensions / Weight	125 x 65.5 x 32 mm / 190 g with batteries	
Power supply	Batteries: 2 x 1.5V LR6 or rechargeable battery Mains connection possible with mains adapter/ micro USB supplied as standard	
Interfaces	2 possible communication modes: Bluetooth wireless link and USB link. The product is then recognized as a USB key for simple file transfers	
Mounting	C.A 1510 casing equipped with a magnet, a wall-mount system and a slot for suspending the product. A wall-mount with anti-theft protection (padlock not supplied) is available as an accessory. A desktop stand is also available (supplied as standard with the C.A 1510W)	

State at delivery

White C.A 1510 delivered in a cardboard box with batteries, 1 USB mains adapter, 1 USB-micro USB cable, desktop stand, quick startup guide, 1 CD-ROM containing the user's manual and data processing software.

Black C.A 1510 delivered in a case with batteries, USB mains adapter, 1 USB cable, quick startup guide, 1 CD-ROM containing the user's manual and data processing software.

Accessories and replacement parts

Black wall-mount.....**P01651024**



Wall-mount



Calibration kit delivered with calibration software

Thermo-anemometers

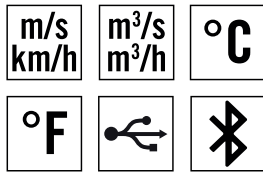

	C.A 1227
Reference	P01654227
Air speed/flow-rate sensor	Vane with optical detection
Air speed range	0.25 m/s to 35.0 m/s (49.0 to 6890.0 fpm)
Air speed accuracy	± 3 % R ± 4 cts
Air flow-rate range	0 to 2,999 m ³ /h
Air flow-rate accuracy	± 8 % R
Temp. range °C/°F	- 20 to +50 °C / - 4 to +122 °F
Temp. accuracy °C	0 to 50 °C: ± 0.8 °C -20 to 0 °C: ± 1.6 °C
Functions	Min., Max., HOLD, Average
Recording	Manual start and stop on the product Programmed recording
Data storage	More than 1 million points
Power supply	- 3 x 1.5V LR6 alkaline batteries or NiMH rechargeable battery - Mains connection via the mains / micro USB adapter (option)
Battery life	200 hrs (portable mode) / 8 days for recording (15-minute measurement interval)
Dimensions	Casing: 150 x 72 x 32 mm Sensor: 160 x 80 x 38 mm Spiral cable: 24 to 120 cm
Weight	Approx. 400 g
Ingress protection	IP40 casing
Operating temperature / humidity	-10 to +60 °C - 10 to 90 % RH
Standards	IEC 61010-1 - IEC 61326-1

State at delivery



C.A 1227 delivered with carrying bag, 3 x 1.5V AA alkaline batteries, USB cable, measurement report and quick startup guide (complete manual and Data Logger Transfer software available from the Chauvin Arnoux website)

Luxmeters

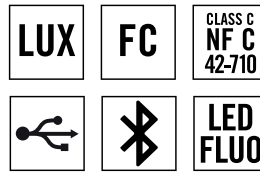

	C.A 1110
Reference	P01654110
Measurement range	0.1 to 200,000 lx 0.01 to 18,580 fc
Accuracy in standard mode	
Incandescent lamp	± 3 % of reading
LED	± 6 % of reading (3,000 K and 6,000 K)
Fluorescent lamps	± 9 % of the reading
Accuracy in compensation mode	
LED mode	± 4 % of the reading (at 4,000 K)
Fluo mode	± 4 % of the reading (type F11, 4,000 K)
Functions	Min., Max., HOLD, Average
Recording	Manual start and stop on the product Programmed recording
MAP mode	The MAP function can be used to map the lighting on a surface or in a room. The illuminance measurements are this stored in the same file.
Data storage	More than 1 million points
Power supply	- 3 x 1.5V LR6 batteries or NiMH rechargeable battery - Mains connection via the mains / micro USB adapter (option)
Battery life	500 hrs (portable mode) / 3 years for recording (15-minute measurement interval)
Dimensions	Casing: 150 x 72 x 32 mm Sensor: 67 x 64 x 35 mm (with protective cover) Spiral cable: 24 to 120 cm
Weight	345 g with batteries
Ingress protection	IP50 casing
Operating temperature / humidity	-10 to +60 °C - 10 to 90 % RH
Standards	Class C according to the NF C 42-710 standard

State at delivery

C.A 1110 delivered with carrying bag, 3 x 1.5V AA alkaline batteries, USB cable, measurement report and quick startup guide (complete manual and Data Logger Transfer software available on the Chauvin Arnoux website).



Accessories and replacement parts for the C.A 1227 & C.A 1110

Cones kit for vane flow-rate measurement for C.A 1227 (circular cross section Ø 210 mm and rectangular cross section 346 x 346 mm) **P01654250**
 Ø 80 mm vane sensor for C.A 1227 **P01654251**
 Shockproof sheath + Multifix **P01654252**
 Multifix **P01102100Z**

Mains adapter **P01651023**
 Carrying bag **P01298075**
 Metal case **P01298071**
 Dataview software **P01102095**
 Bluetooth BLE / USB modem for PC **P01654253**
 4 x NiMH AA/LR6 batteries + Charger **HX0053**

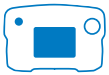

Assessing the safety of your installations

measurements according to the applicable European

standards:

IEC 60364,

EN 61557,

NF C 15-100,

VDE 0100,

NIN/NIV,

IEE 17th.

Electrical installation sensors enable electricians to certify the safety of the infrastructures for which they are responsible, whatever the environment.

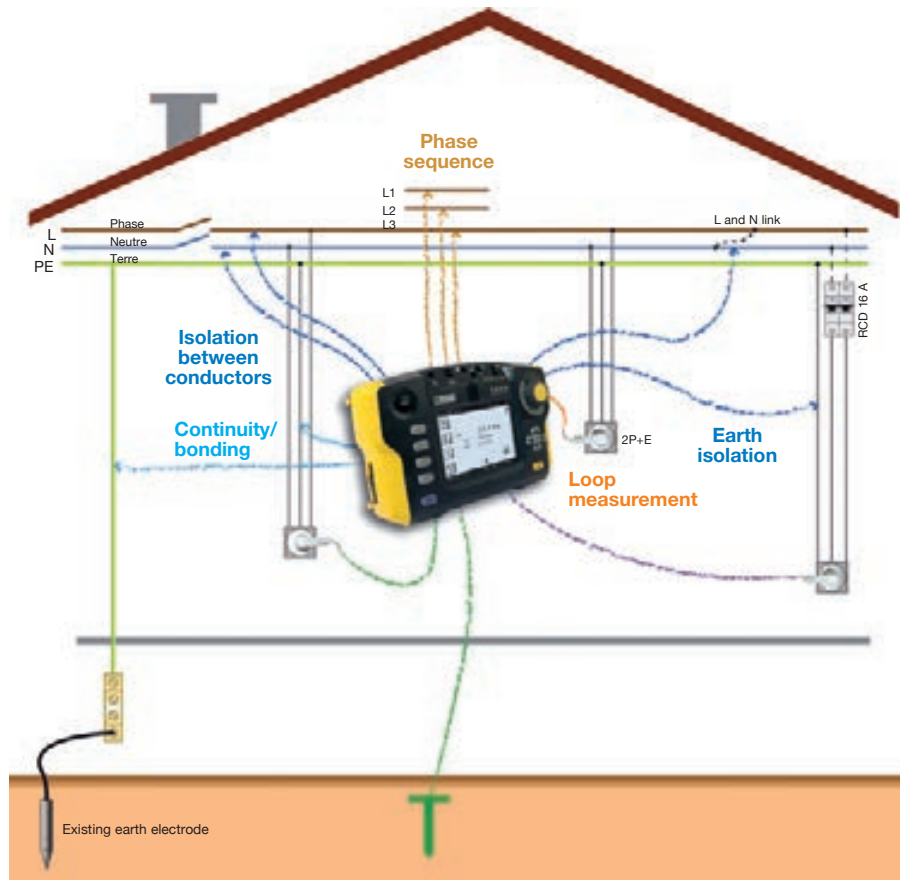

ISOLATION (IEC/EN 61557-2)

Measurement without voltage

Why measure the isolation?

- To check that there is no mechanical deterioration of the conductors
- To check the conductors' isolation in relation to the earth

Voltage of l'installation	Test voltage	Necessary isolation
< 50 V	250 V	≥ 250 kΩ
50 V to 500 V	500 V	≥ 500 kΩ or ≥ 1 MΩ depending on standards
> 500 V	1000 V	≥ 1 MΩ

EARTH (IEC/EN 61557-5)

Why measure the earth and how?

- Using the method with a single auxiliary stake (TT and impedant IT networks)
- The Ra value must be as low as possible to allow the fault currents to flow to earth

PHASE SEQUENCE (IEC/EN 61557-7)

How can I identify the different phases in a three-phase network?

- By a clear indication of their rotation direction.

CONTINUITY / BONDING (IEC/EN 61557-4)

(I ≥ 200 mA)

Why test the bonding?

- A PE conductor in good condition correctly connected to the earth plate will allow the fault currents to flow to earth.

RCDs (IEC/EN 61557-6)

Why check the RCDs?

- To check that they trip:
 - During the test = IΔN
 - In less than 300 ms for the standard types and 500 ms for selective RCDs, at a current between IΔN/2 and IΔN.

LOOP (IEC/EN 61557-3)

Why measure the loops?

- To measure the earth by excess without stakes
- To calculate the short-circuit current in order to size the safety devices appropriately
- To check the fault voltage (with probe connected)

Installation testers

600 V
CAT III

IP
53



C.A 6116N

C.A 6117

BONDING / RÉSISTANCE	
I rated / Range / Resolution	I > 200 mA / 39.99 Ω / 0.01 Ω / ± (1.5 % of reading + 2 cts) 12 mA / 39.99 Ω and 399.9 Ω / 0.01 and 0.1 Ω / ± (1.5 % of reading + 5 cts) with buzzer
Range/ Resolution / Accuracy	4 kΩ / 1 Ω / ±(1.5 % of reading + 5 cts) • 40 kΩ - 400 kΩ / 10 Ω - 100 Ω / ±(1.5 % of reading + 2 cts)
ISOLATION	
Rated voltage	Utest : 50 /100 / 250 / 500 / 1,000 V DC
Range / Basic accuracy	0.01 MΩ to 2 GΩ / 10 kΩ to 1 MΩ / ±(5 % of reading + 3 cts)
Short-circuit current	≤ 3 mA
EARTH	
3P earth	0.50 Ω to 40 Ω / 0.01 Ω / ±(2 % of reading + 10 cts) • 40 Ω to 15 kΩ / 0.1 Ω to 1 Ω / ±(2 % of reading + 2 cts) 15 kΩ to 40 kΩ / 10 Ω / ±(10 % of reading + 2 cts)
Range / Resolution / Accuracy	
Others	Resistance measurement of RH & RS auxiliary stakes (up to 40 kΩ)
Ufk	Compliant with SEV 3569
1P SELECTIVE EARTH	
Range / Resolution / Accuracy	0.50 Ω to 39.99 Ω - 40 Ω to 399.9 Ω / 0.01 Ω - 0.1 Ω / ±(10 % of reading + 10 cts) (ISel via clamp)
LOOP IMPEDANCE (Zi (L-PE) and Zs (L-N or L-L) - 1P LIVE EARTH	
LIVE EARTH	
Installation voltage / frequency	90 to 500 V / 15.8 to 17.5 Hz - 45 to 65 Hz
High current TRIP mode	Max. test current: 7.5 A
Zs (L-PE) & Zi (L-N or L-L)	(0.050) 0.100 Ω to 0.5 Ω / 0.001 Ω / ± (10 % of reading + 20 cts) • 0.5 Ω to 3,999 Ω / 0.001 Ω / ± (5% of reading + 20 cts)
Range / Resolution / Accuracy	3.999 to 39.99 Ω / 0.01 Ω / ± (5 % of reading + 2 cts) • 40.0 Ω to 399.99 Ω / 0.1 Ω / ± (5% of reading + 2 cts)
NO TRIP mode (Zs (L-PE) only)	Test current: 6 mA - 9 mA - 12 mA (as required) • 0.20 Ω to 0.99 Ω / 0.01 Ω / ± (15 % of reading + 10 cts) 1.00 to 1.99 Ω / 0.01 Ω / ± (15 % of reading + 3 cts) • 2.00 to 39.99 Ω / 0.01Ω / ± (10 % of reading + 3 cts) 40.00 Ω to 399.9 Ω / 0.1 Ω / ± (5 % of reading + 2 cts) • 400 to 3,999 Ω / 1 Ω / ± (5 % of reading + 2 cts)
Calculation of short-circuit current Ik (PFC (Zs)) , I Sc PSCC (Zi)	Fault and short-circuit current: 0.1 A to 20 kA
Table of integrated fuses	Yes
Voltage drop ΔV%(Zi)	-40 % to +40 %
Others	Measurement of the resistive and inductive components of the impedances Zs and Zi
TYPE AC and A RCDs	
Tension de l'installation / Fréquence	90 V to 500 V / 15.8 Hz to 17.5 Hz and 45 Hz to 65 Hz
IΔn	6/30/100/300/500/650/1000 mA (90 V - 280 V) or variable 6/10/30/100/300/500 mA (280 V - 550 V) or variable Ramp and pulse test
Test de non-déclenchement	At ½ IΔn - Duration: 1,000 ms or 2,000 ms
Mode rampe	0.2 to 0.5 x IΔn (Uf) / 0.3 x IΔn to 1.06 x IΔn in increments of 3.3 % x IΔn
Mesure du temps de déclenchement : Gamme / résolution / Précision	0.2 to 0.5 x IΔn (Uf) / 0.5 x IΔn / 2 x IΔn (selective) / 5 x IΔn Pulse: 0 to 500 ms / 0.1 and 1 ms / 2 ms, Ramp mode (10) to 200 ms / 0.1 ms / 2 ms
TYPE B RCDs	
Installation voltage / frequency	90 V to 280 V / 15.8 Hz to 17.5 Hz and 45 Hz to 65 Hz
IΔn: ramp / pulse 2 x IΔn pulse 4 x IΔn	6/10/30/100/300/500 mA 6/10/30/100 mA en impulsion 4 IΔn Duration: 150 ms in 4 x IΔn or 300 ms with 2 x IΔn
Test in ramp mode	0.2 x IΔn to 2.2 x IΔn
Tripping time: 2 x IΔn 4 x IΔn	IΔn ≤ 200 mA : 2.2 x 2 x IΔn IΔn > 200 mA : 1.1 x 2 x IΔn IΔn ≤ 100 mA : 2.2 x 4 IΔn
OTHER MEASUREMENTS	
Current via C177A clamp	5.0 mA to 199.9 A (C177A)
Current via MN77 clamp	(1 mA*) 5.0 mA to 19.99 A
Voltage	0 to 550 VAC/DC / DC and 15.8 to 450 Hz
Frequency	15.8 to 500 Hz
Phase sequence	20 to 500 VAC
Active power	0 to 110 kW single-phase - 0 to 330 kW three-phase - Simultaneous display of voltage and current waveforms
Harmonics	Voltage and current / up to 50th order / THD-F / THD-R
GENERAL SPECIFICATIONS	
Display	Large 5.7" graphical colour LCD screen with backlighting, 320 x 240 points
Storage/communication	1,000 tests / via USB for data transfer and report creation
Power supply: rechargeable battery	Lithium-ion 10.8 V rated 5.8 AH
Battery life	up to 30 hours
Dimensions / weight	280 x 190 x 128 mm / 2.2 kg
Ingress protection	IP 53 / IK04
EMC	IEC 61326-1
Electrical safety	IEC 61010 -1 - 600 V CAT III - 300 V CAT IV - IEC 61557

* if a voltage is connected to the instrument

State at delivery

• C.A 6116N • C.A 6117:

1 tester delivered with a carrying bag, 1 type-2 mains power pack / charger, 1 Li-Ion battery pack, 1 USB A/B cable, 1,80 m, with ferrite, 1 three-point cable - 3 safety leads (red, blue and green), 3 test probes, Ø 4mm (red, blue and green), 3 crocodile clips (red, blue and green), 2 elbowed-straight safety leads, 3 m (red and black), 1 three-point Euro mains cable, 1 x 2P EURO mains cable, 1 remote-control probe, 1 wrist strap, 1 scratch-proof film mounted on the instrument, 1 x 4-point hands-free strap, ICT data export software on CD-ROM, 6 operating manuals on CD (one per language), 1 safety datasheet in 20 languages.

References

• C.A 6116N EURO Contrôleur.....	P01145455 X*
• C.A 6117 EURO Contrôleur.....	P01145460 X*

*FR version A=X, IT version A= B, CH version A= C, US version A=D





Insulation and Continuity Testers

Discover our new range:

- > Test voltage from 10 V to 1,000 V / 200 GΩ
- > Manual, Lock, Timer and PI / DAR Ratios modes
- > Visual Pass / Fail: red / green
- > 200 mA / 20 mA continuity with active protection without fuses
- > Measurement of V (TRMS & DC), F, Ω, kΩ, C and cable length
- > ΔRel mode & configurable alarms
- > Storage of measurements in memory



600 V
CAT IV

IP
54

IEC
61557



TRMS

Choose your tester to match your needs:

C.A 6536	C.A 6532	C.A 6522, C.A 6524, C.A 6526	C.A 6534
<p>"Special & ESD" applications</p> <p>With a variable test voltage from 10 V to 100 V in 1 V increments, this model is intended for special applications in sectors such as avionics, space and defence, which often require a low test voltage and strict adherence to the programmed value. With appropriate electrodes, the 10 V and 100 V test voltages can also be used for electrostatic discharge applications.</p>	<p>"Telecommunications" applications</p> <ul style="list-style-type: none"> • Insulation tests at 50 V or 100 V • Specific functions: measurement of resistance, capacitance, leakage current and AC voltage. • Measurement of the difference in resistance between 2 wires in a pair by using the ΔREL function. • Display of the length of the line being tested, thanks to programming of the linear capacitance in nF/km. 	<p>"Industrial Maintenance" applications</p> <p>Periodic insulation tests on installations and equipment help to prevent incidents by setting up preventive maintenance designed to detect ageing and premature deterioration of their insulation characteristics:</p> <ul style="list-style-type: none"> • Measurement of insulation over a programmed duration • Alarms and Pass/Fail indicator light (C.A 6526) • PI and DAR ratios to determine the quality of the insulation, with the advantage of not being significantly influenced by the temperature • Storage in memory to compare the measurement histories 	<p>"Electronics" applications</p> <p>Thanks to its wide test-voltage range from 10 V to 500 V, this model covers the specific requirements of the electronics industries, for both low-current applications and power stages. Its measurement range is from 2 kΩ to 50 GΩ.</p>

Remote control probe

The remote control probe is an accessory specially developed to make your insulation tests in the field simpler and quicker.

- Insulation measurement can be triggered with a single press on the probe's yellow button.
- Equipped with a torch function, this probe effectively lights the point of measurement.
- Thanks to the tester's backlit screen, the measurement results are visible at all times, including in places with poor lighting.



Reference | P01102092A

DataView® software

DataView® software, with its Megohmmeter Transfer module, automatically recognizes the instrument when it is connected to the PC and opens the corresponding menu. This tree-structure menu offers users direct access to the data recorded in the instrument and its configuration.

The other functions available are:

- Activation of remote tests
- Real-time display
- DAR and PI references
- Graphical plot of the tests
- Generation of measurement reports

Reference | P01102095





	C.A 6522	C.A 6524	C.A 6526	C.A 6532	C.A 6534	C.A 6536
Reference	P01140822	P01140824	P01140826	P01140832	P01140834	P01140836
Application	Industrial Maintenance			Telecom	Electronics / ESD	Special
Voltage	0.3V - 399.9 V / 0.1 V; 400V-700V / 1V					
Measurement range / Resolution	+/- (3% + 2cts) / 400 kΩ					
Accuracy / Input impedance	DC; 15.3 - 800 Hz					
Operating frequency	Frequency					
Measurement range / Resolution / Accuracy	"15.3 Hz- 399.9 Hz / 0.1 Hz / +/- (0.5% + 2cts) ; 400-800 Hz / 1 Hz / +/- (1% + 1ct)"					
Insulation	Test voltage					
Test voltage	250-500-1,000V	50 - 100 - 250 - 500 - 1 000 V	50 - 100 V	10 - 25 - 100 - 250 - 500 V	10 to 100V in 1V increments	
Range at maximum test voltage	40 GΩ	200 GΩ	20 GΩ	50 GΩ	20 GΩ	20 GΩ
Compliance with IEC 61557-2 standard	2 GΩ		2 GΩ		2 GΩ	2 GΩ
Measurement range: 10 V					2 kΩ - 1 GΩ	2 kΩ - 2 GΩ
25 V					5 kΩ - 2 GΩ	(U _v /5) kΩ - (U _v /5) GΩ
50 V			10 kΩ - 10 GΩ			
100 V			20 kΩ - 20 GΩ			
250 V	50 kΩ - 10 GΩ	50 kΩ - 50 GΩ	20 kΩ - 20 GΩ		20 kΩ - 10 GΩ	20 kΩ - 20 GΩ
500 V	100 kΩ - 20 GΩ	100 kΩ - 100 GΩ			50 kΩ - 25 GΩ	
1,000 V	200 kΩ - 40 GΩ	200 kΩ - 200 GΩ			100 kΩ - 50 GΩ	
Variable test voltage						10 V to 100 V
Measurement range / resolution	10 ⁽¹⁾ -999 kΩ and 1,000-3,999 MΩ / 1 kΩ; 4,00- 39,99 MΩ / 10 kΩ; 40,0-399,9 MΩ / 100 kΩ; 400 - 3999 MΩ / 1 MΩ; 4,00 - 39,99 GΩ / 10 MΩ; 40,0 - 200 GΩ / 100 MΩ					
Accuracy	± (3 % + 2 cts) ⁽²⁾					± (3 % + 2 cts) ⁽³⁾
Test voltage (I < 1 mA)	-0 % + 20 %					± 0,5 V
Display of test voltage	± (3 % + 3 cts)					± (3 % + 3 cts)
Display of test current / resolution	0,01 µA - 39,99 µA / 10 nA; 40,0-399,9 µA / 100 nA; 0,400-2,000 mA / 1 µA					
Accuracy of test current	± (10 % + 3 cts)					
PI/DAR ratios	10 mn / 1 mn - 1 mn / 30 s					
Timer (min:s)	0:00 - 39:59					
Discharge time (at 25 V)	< 2 s/µF					
Alarms	2 fixed thresholds + 1 programmable threshold					
Continuity	Range for continuity measurement					
Range for continuity measurement	0,00 Ω - 10,00 Ω (200 mA)	0,00 Ω - 10,00 Ω (200 mA) ; 0,0 - 100,0 Ω (20 mA)				
Accuracy / Open-circuit voltage	± (2 % + 2 cts) / ≥ 6 V					
Measurement current	-0%+4%					
Continuity thresholds (quick beep)	2 Ω fixed	2 Ω, 1 Ω, 2Ω, 1Ω, programmable threshold				
Compensation of cables	up to 9,99 Ω					
Resistance	Measurement range / Resolution / Accuracy					
Measurement range / Resolution / Accuracy	0 - 3999 Ω / 1 Ω; 4,00 kΩ - 39,99 kΩ / 10 Ω / ± (3 % + 2 cts) 40,0 kΩ - 399,9 kΩ / 100 Ω; 400 kΩ - 1 000 kΩ / 1 kΩ / ± (3 % + 2 cts)					
Capacitance	Measurement range / resolution					
Measurement range / resolution	0,1 nF - 399,9 nF / 0,1 nF 400 nF - 3999 nF / 1 nF 4,00 µF - 10,0 µF / 10 nF ± (3 % + 2 cts)					
Accuracy	Line length					
Line length	0 - 100 km					
General specifications	Display					
Display	2 x 4,000 cts + logarithmic bargraph					
Storage	300 measurements		1,300 measurements			
Communication	Bluetooth® Classe II					
Power supply / Automatic shutdown	6 x LR6(AA) batteries / 5 min , deactivatable					
Battery life	1,500/2,500/6,000 measurements ⁽⁴⁾ ; UN x 1 kΩ @ UN (5s ON / 5s OFF); 3,000 continuity measurements (5s ON / 5s OFF)					
Dimensions (h x w x d) / Weight / IP rating	211 x 108 x 60 mm / 850 g / IP 54 / IK 04					
EMC / Electrical safety	IEC 61326-1 / IEC 61010-1 and IEC 61010-2-030, 600V CAT IV					
Compliance with standards	IEC 61557 parts 1, 2, 4 and 10					

(1) : 2 kΩ for C.A 6532 - C.A 6534 - C.A 6536 – (2): to be added: 10 V: 1% per 0.1 GΩ; 25 V: 0.4% per 0.1GΩ; 50 V: 2% per GΩ; 100 V: 1% per GΩ; 250 V : 0.4% per GΩ; 500 V: 0.2% per GΩ; 1,000 V: 0.1% per GΩ – (3): 10%/UN is added per 100 MΩ – (4): depending on the model.

Accessories and replacement parts

Continuity rod	P01102084A	2 wire grips (red and black)	P01102053Z
C.A 861 thermometer + K thermocouple	P01650101Z	Carrying bag for hands-free use	P01298049
2 elbowed-straight safety leads (red and black) 1.50 m long.	P01295453Z		
2 crocodile clips (red and black)	P01295457Z		
2 test probes (red and black)	P01295454Z		

State at delivery

- **C.A 6522 et C.A 6524** delivered with a carrying bag for hands-free use, 2 elbowed-straight safety leads (red and black) 1.50 m long, one red crocodile clip, one black test probe, 6 x LR6 or AA batteries, multilingual user's manual on CD, a quick start-up guide, multilingual safety datasheet.
- **C.A 6526**, ditto + a CD containing the Megohmmeter Transfer software.
- **C.A 6532 and C.A 6534**, same as C.A 6526 + 2 wire-grips (red and black).
- **C.A 6536**, same as C.A 6524 + 2 wire-grips (red and black).





ELECTRICAL TESTING AND SAFETY

IP 53

Insulation testers



	C.A 6541	C.A 6543	C.A 6505	C.A 6545	C.A 6547	C.A 6549
	<i>Quantitative and qualitative measurement</i>	<i>Saving of measurements Rechargeable battery</i>	<i>Insulation and leakage current</i>	<i>Insulation, capacitance, current</i>	<i>Storage and communication</i>	<i>For preventive maintenance professionals</i>
Reference	P01138901	P01138902	P01139704	P01139701	P01139702	P01139703
Voltage	1 to 1,000 V _{AC/DC}		1 to 5,100 V _{AC/DC}			
Insulation	50 / 100 / 250 / 500 / 1,000 V _{DC}		500/1,000/ 2,500 / 5,000 V _{DC} + variable from 50 V to 5,100 V _{DC} (10 or 100 V increments)			
Range	2 kΩ to 4 TΩ		10 kΩ to 10 TΩ			
Continuity	0.01 to 40 Ω (buzzer + cable compensation)					
Resistance	0.01 to 400 kΩ					
Capacitance	0.005 to 4.999 μF		0.001 to 49.99 μF			
Current			0.001 nA to 3,000 μA			
Voltage ramp mode						5 steps
R calcul. (ref. T°)						yes
Alarms	yes					
Smoothed display	yes		no	yes		
Chronometer	yes					
Prog. test time	yes					
Quality ratios	DAR / PI			DAR / PI / DD		
R(t)	storage of samples		no	storage of samples		display on screen
Storage		128 kB		4 kB	128 kB	
Communication		two-way		no	two-way	
Power supply	8 x LR14 batteries		NiMH rechargeable battery			
Safety	IEC 61010-1 Cat. III 600 V IEC 61557		IEC 61010-1 Cat. III 1000 V (Cat. I, 2,500 V)- IEC 61557			
Display	giant LCD + bargraph		giant LCD + bargraph			graphic
Backlighting	yes					
Dimensions	240 x 185 x 110 mm		270 x 250 x 180 mm			
Weight	3.4 kg		4.3 kg			
PC software	no	DataView® (option)	no	no	DataView® (option)	
State at delivery	carrying bag containing: 3 leads 1.5 m long (including one shielded), 3 crocodile clips, 1 test probe + batteries or power cable		carrying bag containing: 3 HV leads 2 m or 3 m long with large crocodile clips (including one shielded), 1 lead with rear connection (35 cm) + 1 power cable			

DataView® software for C.A 6543, C.A 6547 and C.A 6549

DataView®:
the essential tool for configuring and performing the measurements, viewing the data in real time, recovering the recorded data and creating standard or customized measurement reports..... **P01102095**

Accessories and replacement parts

C.A 1246 thermo-hygrometer for C.A 6505/6545/6547/6549	P01654246
C.A 1821 thermometer.....	P01654821
Remote-control probe for CA 6541/CA6543	P01101935

Digital insulation testers

- > Wide measurement range from 10 kΩ to 30 TΩ
 - 5 mA charging current
 - Large backlit LCD screen with digital display, bargraph and R(t)+u(t), i(t) and i(u) graphs
 - Automatic calculation of DAR / PI / DD / ΔR (ppm/V) ratios
- > 3 filters to optimize measurement stability



**1000 V
CAT IV** **IP
54**

	C.A 6550	C.A 6555
Reference	P01139705	P01139706
Voltage	10 kV	15 kV
Insulation	500/1,000/2,500/5,000/10,000 V	500/1,000/2,500/5,000/10,000/15,000 V
Range	10 kΩ to 25 TΩ	10 kΩ to 30 TΩ
Resistance	Yes	
Capacitance	0.001 - 9.999 μF / 10.00 - 49.99 μF	
Current	Leakage current from 0 to 10 mA	
Voltage ramp mode	3 pre-configurable ramps	
R calcul. (ref. T°)	Yes	
Alarms	Yes	
Smoothed display	Yes	
Chronometer	Yes	
Prog. test time	Yes	
Quality ratios	DAR / PI / DD / ΔR (ppm/V)	
R(t)	Display on screen	
R(t) + U(t), I(t), I(u)	Graphic display of curves	
Storage	256 kB, up to 80,000 recordings	
Communication	Optically-isolated port for USB link	
Power supply	NiMH battery rechargeable with external voltage	
Safety	1,000 V Cat. IV - IEC 61010-1 and IEC 61557	
Backlighting	Yes	
Dimensions	340 x 300 x 200 mm	
Weight	6.2 kg	

State at delivery

Delivered with bag containing :

- 2 safety leads 3m long equipped with an HV connector at each end (red / blue),
- shielded safety lead 3 m long equipped with an HV connector at one end and an HV connector with rear connection (black) at the other end,
- 3 crocodile clips (red, blue, black),
- 2 x CAT IV 1000 V test probes (red, black) for voltage measurement,
- 1 blue lead with rear connection,
- 1 mains power cable 2 m long,
- DataView® software,
- 1 optical / USB communication lead,
- 1 operating manual in 5 languages on CD-ROM

Accessories

3 HV leads with croc. clips for 10/15 kV	P01295466
Blue 8 m HV lead with croc. clips	P01295468
Red 8 m HV lead with croc. clips	P01295469
Black 8 m HV lead with croc. clips	P01295470
Blue 15 m HV lead with croc. clips	P01295471
Red 15 m HV lead with croc. clips	P01295472
Black 15 m HV lead with croc. clips	P01295473
3 x 3 m HV leads for 10/15 kV	P01295465
50 cm HV lead with rear connection	P01295467
2 red/black test probes	P01295454Z
3 crocodile clips: red/blue/black	P01103062
Bag	P01298066



ELECTRICAL TESTING AND SAFETY

Earth and resistivity testers



		C.A 6460	C.A 6462	C.A 6470N	C.A 6471
Reference		P01126501	P01126502	P01126506	P01126505
3P Method	Range	0.01 to 2,000 Ω		0.01 Ω to 99.99 kΩ	
	Resolution	10 mΩ/100 mΩ/1 Ω		0.01 to 100 Ω	
	Measurement frequency	128 Hz		41 to 513 Hz	
	Coupling measurement	Yes		Yes (Automatic)	
4P Method	Range	0.01 to 2,000 Ω		0.001 Ω to 99.99 kΩ	
	Resolution	10 mΩ/100 mΩ/1 Ω		0.001 to 100 Ω	
	4P Selective			Yes	
Earth measurement with 2 clamps	Range			0.01 to 500 Ω	
	Resolution	No		0.01 to 1 Ω	
	Measurement frequency			Auto: 1611 Hz Manual: 128 Hz, 1367 Hz, 1611 Hz, 1758 Hz	
Resistivity	Test method	Wenner et Schlumberger		Wenner and Schlumberger with automatic calculation	
	Range	0.01 to 2,000 kΩ		0.01 to 99.9 kΩ	
	Measurement frequency	128 Hz		41 to 128 Hz	
DC resistance measurement	Type of measurement			2 or 4 wires	
	Range	No		0.12 Ω / 0.020 Ω to 99.9 kΩ	0.12 Ω / 0.020 Ω to 99.9 kΩ
	Measurement current			> 200 mA DC	
Storage	No		512 memory locations		
Communication	No		Optically-isolated USB		
Dimensions / weight	273 x 247 x 127 mm / 2.8 kg / 3.3 kg		272 x 250 x 128 mm / 3 kg / 3.2 kg		
Safety	50 V CAT III, IEC 61010 & IEC 61557		50 V CAT IV, IEC 61010 & IEC 61557		
Power supply	8 x 1.5 V LR6 batteries		NiMH battery		

State at delivery

- **C.A 6460** : delivered with 8 x 1.5 V LR6 batteries and 1 operating manual in 5 languages
- **C.A 6462**: delivered with 1 mains lead for recharging and 1 operating manual in 5 languages
- **C.A 6470N**: delivered with 1 external mains charger, data export software + optical / USB communication lead, 5 operating manuals (one per language) on CD-ROM, 5 simplified operating manuals, each in a different language, 5 descriptive labels, each in a different language
- **C.A 6471**: delivered with 1 external mains charger, data export software + optical / USB communication lead, 2 C182 clamps with 2 safety leads, 5 operating manuals (one per language) on CD-ROM, 5 simplified operating manuals, each in a different language, 5 descriptive labels, each in a different language, 1 carrying bag.

Accessories

C.A 6471

- MN82 clamp (diam. 20mm) (delivered with 1 x 2m cable for ES terminal connection) . . **P01120452**
- C182 clamp (diam. 20mm) (delivered with 1 x 2m cable for ES terminal connection) . . **P01120333**

Earth and resistivity kit (100 m kit)

Ref.: **P01102024**

Compartment bag with space for tester containing: 4 "T"-shaped rods, 4 coils of cable (100 m red, 100 m blue, 100m green, 30 m black), 1 green 10 m cable coiler, 1 mallet, 5 x Ø 4 mm lug/banana plug adapters



Standard 3P-method earth kit

50 m kit Ref.: P01102021

Carrying case containing: 2 "T"-shaped rods, 2 coils of cable (50 m red, 50 m blue), 1 green 10 m cable coiler, 1 mallet, 5 x Ø 4 mm lug/banana plug adapters

100 m kit Ref.: P01102022

Carrying case containing: 2 "T"-shaped rodss, 2 coils of cable (100 m red, 100 m blue), 1 green 10 m cable coiler, 1 mallet, 5 x Ø 4 mm lug/banana plug adapters

For the C.A 6471 and C.A 6470N

- Dataview report generation software **P01102095**
- Adapter for recharging on vehicle cigarette lighter. **P01102036**
- Optical / RS communication cable **P01295252**
- GB mains power cable **P01295253**
- Set of 10 fuses - F 0.63 A - 250 V - 5x20 mm - 1.5 kA . . . **AT0094**
- Adapter for charging battery from the mains **P01102035**
- Battery pack **P01296021**
- Optical / USB communication cable. **HX0056-Z**

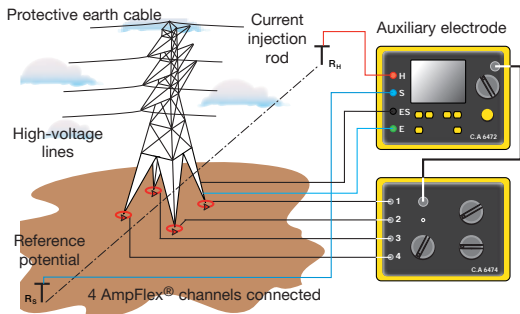

Earth and resistivity tester with adapter for pylon earth measurements

The C.A 6472 can be used to carry out a quick but comprehensive survey of all earthing configurations. When used with the C.A 6474 accessory, it allows users to measure the earth resistance of pylons.



	C.A 6472	Accessory C.A 6474
Reference	P01126504	P01126510
Specifications		
Measurements	Earth / Selective earth / Resistivity / Coupling / Continuity / Ground potential / Pylon earth (with C.A 6474)	Overall pylon earth Earth resistance of each pylon footing Overall line impedance Quality of the protective earth cable connection
Type	Methods: 3P / 4P / 4P with clamp / 2 clamps	Active measurement (injection by C.A 6472) Passive measurement (use of disturbance currents)
Measurement range	0.011 to 100 kΩ (automatic ranging)	
No-load voltage	16 V or 32 V (as required)	
Frequency	41 Hz to 5078 Hz	
Frequency sweep	Yes	
Auxiliary rod resistance measurement	Yes: 0.14 Ω to 100 kΩ	
U disturbance		
Measurement	0,00 to 65,0 V	
Noise rejection	Yes	
Power supply	Rechargeable NiMH battery	Powered by the C.A 6472
Display	3 digital LCD screens	
Storage	512 storage locations	
Communication output	Optical / USB link	
Safety	IEC 61010 & IEC 61557	
Dimensions / weight	272 x 250 x 128 mm / 3.2 kg	272 x 250 x 128 mm / 2.3 kg

State at delivery

- **C.A 6472:** delivered with mains adapter + 2P mains plug for battery recharging on mains, data export software + optical / USB communication cable, 2 x C182 clamps, 2 safety leads, 5 operating manuals (one per language) on CD-ROM, 5 simplified operating manuals (one per language), 5 identification labels (one per language), 1 bag.
- **C.A 6474:** delivered with an accessories bag containing 1 connection cable, 6 BNC/BNC cables 15 m long, 4 flexible current sensors (AmpFlex®) 5 m long, 1 set of 12 identification rings for AmpFlex®, 2 cables (5 m green, 5 m black) with safety plugs on winder, 5 spade lug/Ø 4 mm banana plug adapters, 3 clamps, 1 calibration loop, 5 operating manuals and 5 specification labels, each in a different language.

Earth and Resistivity Kit (100m Kit)
see page 16



Accessories

C.A 6472

- MN82 clamp (diam. 20mm) (delivered with 1 x 2m cable for ES terminal connection) . . . P01120452
- C182 clamp (diam. 20mm) (delivered with 1 x 2m cable for ES terminal connection) . . . P01120333

For the C.A 6472 and C.A 6474 :

- C.A 6472 – C.A 6474 connection cable P01295271
- 15 m BNC / BNC cable. P01295272
- 5 m AmpFlex® flexible current sensor for C.A 6474. P01120550

- Set of 12 AmpFlex® identification rings P01102045
- Set of 3 adjustable clamps P01102046
- 5 m green cable for C.A 6474 (E terminal connection). P01295291
- 5 m black cable for C.A 6474 (ES terminal connection). P01295292
- Spade lug/Ø 4 mm banana plug adapters P01102028
- Calibration loop P01295294
- AmpFlex® flexible current sensors:
other lengths available on request



Earth Clamps and Loop Testers

600 V
CAT IV

IP
40



	C.A 6416	C.A 6417
Reference	P01122015	P01122016
Specifications		
Loop ohmmeter 1,500-count display	Measurement ranges (Ω) / Resolution (Ω) / Accuracy	
	0.010 to 0.099 / 0.001 / ±1.5 % ±0.01	
	0.10 to 0.99 / 0.01 / ±1.5 % ±2 r	
	1.0 to 49.9 / 0.1 / ±1.5 % ±r	
	50.0 to 99.5 / 0.5 / ±2 % ±r	
	100 to 199 / 1 / ±3 % ±r	
	200 to 395 / 5 / ±5 % ±r	
	400 to 590 / 10 / ±10 % ±r	
Frequency	Measurement frequency: 2083 Hz / Transposition frequency: 50, 60, 128 or 2083 Hz	
	Measurement ranges (μH) / Resolution (μH) / Accuracy	
Loop inductance measurement	10 to 100 / 1 / ±5 % ±r	
	100 to 500 / 1 / ±3 % ±r	
Contact voltage	Measurement ranges (V) / Resolution (V)	
	0.1 to 4.9 / 0.1	
	5.0 to 49.5 / 0.5	
Ammeter Measurement ranges (A) / Resolution (A) / Accuracy 4,000-count display	50.0 to 75.0 / 1	
	Measurement ranges (A) / Resolution (A) / Accuracy	
	0.200 to 0.999 mA / 1 μA / ±2 % ±50 μA	
	1.000 to 2.990 mA - 3.00 to 9.99 mA / 10 μA / ±2 % ±50 μA	
	10.00 to 29.90 mA - 30.0 to 99.9 mA / 100 μA / ±2 % ±r	
Setup	100.0 to 299.0 mA - 0.300 to 0.990 A / 1 mA / ±2 % ±r	
	1.000 to 2.990 A - 3.00 to 39.99 A / 10 mA / ±2 % ±r	
Modes	Standard or advanced	
Alarms	Configurable on Z, V and A	
Buzzer	Active	
HOLD	Manual or automatic PRE-HOLD	
Automatic power-off	Active / Inactive	
General specifications		
Display	152-segment OLED. Active area 48 x 39 mm	
Max. clamping diameter	Ø 35 mm	
Storage	300 time/date-stamped measurements	2,000 time/date-stamped measurements
	Bluetooth Class 2	
Communication		
Power supply	4 x 1.5 V LR6 (AA) alkaline batteries or 4 x Ni-MH batteries	
Battery life	1440 x 30-second measurements	
Calibration	Automatic at start-up	
Electrical safety	IEC 61010 600 V CAT IV	
Protection	IP40	
Dimensions	55 x 95 x 262 mm	
Weight	Approx. 935 g with batteries	

State at delivery

- **C.A 6416:** 1 clamp delivered in a hard case with 4 x 1.5 V batteries, 1 CD-Rom containing the operating manual in 5 languages
- **C.A 6417:** 1 clamp delivered in a hard case with 4 x 1.5 V batteries, 1 CD-Rom containing the operating manual in 5 languages and the GTT software with simplified driver

Accessories

- CL1 calibration loop P01122301
- DataView P01102095
- Hard case P01298080



Locate hidden cables

Locate hidden circuits!

Comprising a transmitter and a receiver, the LOCAT-N provides digital, visual and audio indication of the presence of cables or ducts so that you can follow them intuitively.

300 V
CAT III

Transmitter



Receiver



C.A. 6681 LOCAT-N	
Reference	P01141626
C.A. 6681E transmitter	
Screen	LCD screen with display of functions and bargraph
Output signal frequency	125 kHz
External voltage measurement range	12 to 600 V _{ACDC}
Functions	Digital coding of signals for easy signal identification, selection of transmission signal code, torch function
Power supply	9 V battery
Dimensions	190 x 89 x 42.5 mm
Weight	420 g with battery
Electrical safety	300 V CAT III
C.A. 6681R receiver	
Screen	Backlit LCD with display of functions and bargraph, transmission code, receiver and transmitter battery-charge status
Detection Depth	
> Single-pole application	0 to 2 m
> Two-pole application	0 to 0.5 m
> Simple looping line	Up to 2.5 m
Identification of mains voltage	Approximately 0 to 0.4 m
Functions	Automatic shutdown, automatic or manual adjustment of reception sensitivity, torch function
Power supply	6 x 1.5 V AAA batteries
Dimensions	241.5 x 78 x 38.5 mm
Weight	360 g with batteries

State at delivery

- **C.A. 6681 LOCAT-N:** delivered in a hard case with 1 set of red/black 4 mm isolated banana leads (straight male / elbowed male), 1 set of 2 crocodile clips, 1 stake for earthing, 1 x 9 V battery, 6 x 1.5 V AAA batteries, 1 measurement adapter for B22 socket (bayonet), 1 adapter for E14 socket (screw-in), 1 mains socket adapter and 1 operating manual in 5 languages.





TESTING AND ELECTRICAL SAFETY



NEW PRODUCT

Micro-ohmmeters

- > 4-wire measurement method
- > Test current up to 10 A
- > Resolution 0.1 to 1 $\mu\Omega$

IP 53 50V CAT III

State at delivery

- **C.A 6240** delivered with a bag, a set of 2 x 10 A Kelvin clamps with 3 m cable, 2P European power cable, data export software, 1 optical / USB communication cable
- **C.A 6255** delivered with a bag, a set of cables 3 m long terminated by Kelvin clamps, 2 m Euro mains power cable, CD-ROM containing the MOT (Micro-Ohmmeter Transfer) data transfer software, RS 232 communication cable, CD-ROM containing the user's manual in 9 languages.

	C.A 6240	C.A 6255
<i>Mesure de résistances faibles</i>		
Reference	P01143200	P01143221
Measurement method	4-wire measurement	
Resistance	5 $\mu\Omega$ to 400.0 Ω	1 $\mu\Omega$ to 2,500 Ω
Resolution	1 $\mu\Omega$	0.1 $\mu\Omega$
Accuracy	0.25 %	0.05 %
Current	10 mA to 10 A	1 mA to 10 A
Reversal of current direction	Yes	No but automatic compensation of stray currents
Measurement mode	Normal	Inductive, non-inductive, non-inductive with automatic tripping
Temperature compensation	No	Manual or with Pt 100 probe
Power supply	NiMH rechargeable battery	
Safety	IEC 61010-1 / Cat III 50 V	
Dimensions	270 x 250 x 180 mm	
Weight	4.5 kg	4.5 kg
Data storage	100 measurements	1,500 measurements

Accessories

Double 1 A test probes (x 2).....	P01102056
Mini Kelvin clamp (set of 2).....	P01101783



- > Constant test at 100 A and up to 120 s at 200 A
- > Test current up to 200 A
- > Resistance from 0.1 $\mu\Omega$ to 1 Ω
- > Safe measurements: Both Sides Grounded (BSG) method
- > Storage of up to 8,000 measurement results

IP 54 BSG

	C.A 6292		
Reference	P01143300		
Test current	Programmable from 20 to 200 A		
Resistance	0.1 $\mu\Omega$ to 2 m Ω	2 to 200 m Ω	200 m Ω to 1 Ω
Resolution	0.1 $\mu\Omega$ (200 A max)	10 $\mu\Omega$ (25 A max to 200 m Ω)	1 m Ω (5 A max to 1 Ω)
Output voltage	10 VAC: 4.2 V @ 200 A / 220 VAC: 8.6 V @ 200 A		
Maximum load resistance	100 VAC: 20 m Ω @ 200 A / 220 VAC: 42 m Ω @ 200 A		
Measurement method	4 Kelvin-type connection terminals		
Test mode	Normal or Both Sides Grounded (BSG)		
Test duration	Adjustable from 5 to 120s @200 A / unlimited below 100 A		
Data storage	Up to 8,000 measurement results		
Interface	USB 2.0		
Software	DataView®		
Power supply	100 to 240 VAC – 50/60 Hz		
Dimensions	502 x 394 x 190 mm		
Weight	Approx. 13 kg		
Storage temperature	-10 °C to +70 °C		
Humidity	95% RH		
Protection	Protected against overvoltages, short-circuits and voltage surges on output terminals		
Ingress protection	IP54		
Electrical safety	IEC 61010-1		

Current measurement with the MR6292 clamp available as an option

	MR6292
Reference	P01120470
Measurement range	1.0 - 50.0 Aac
Resolution	0.1 mA
Intrinsic uncertainty	± (1.5% + 2 cts)
Output signal	10 mV / Adc
Load impedance	>100 k Ω // 100 pF
Influence of conductor position in jaws	0.50%

State at delivery

C.A 6292 delivered with:
a case containing 1 set of 2 x 6 m Kelvin leads (red / black) with adjustable-clamp connections, 1 green earth cable 3m long with crocodile clip, 1 USB cable 1.5m long, 1 fuse T 15 A 250V mounted in the instrument, 1 European mains power cable, 1 user's manual in 5 languages on CD-ROM, 1 CD-ROM containing the DataView software.

Accessories / Replacement Parts

1 set of 2 x 15 m Kelvin leads (red / black) adjustable-clamp connections.....	P01295487
1 MR 6292 current clamp for C.A 6292.....	P01120470
1 set of 2 x 6 m Kelvin leads (red / black) adjustable-clamp connections.....	P01295486
1 green earth cable with crocodile clip.....	P01295488
1 set of 5 fuses T 15A 250V 5x20mm.....	P01297101
1 USB-A USB-B cable 1.5m long.....	P01295293



Ratiometer

- > Transformation ratio measurement on power, voltage and current transformers
- > Storage of up to 10,000 measurement results

50 V
CAT IV

IP
53



DTR 8510

Digital ratiometer for transformers

Reference	P01143200	
Range of ratios (VT)	Automatic: 0.8000 to 8,000:1	
Accuracy (VT)	Range of ratios	Accuracy (% of reading)
	0.8000 to 9.9999	± 0.2 %
	10.000 to 999.99	± 0.1 %
	1000.0 to 4999.9	± 0.2 %
	5000.0 to 8000.0	± 0.25 %
Range of ratios (TC)	Autoranging: 0.8000 to 1000.0	
Accuracy (TC)	± 0.5 % of reading	
Excitation signal	VT mode: 32 Vrms max CT mode: Auto level 0 to 1 A, 0.1 to 4.5 Vrms	
Excitation current display	Range: 0 to 1,000 mA; Accuracy: ± (2 % R + 2 mA)	
Excitation frequency	70 Hz	
Display	Alphanumeric LCD, 2 lines of 16 characters with adjustment of contrast and backlighting. Easy to read in both daytime and nighttime conditions	
Available languages	French, English, Spanish, Italian, German, Portuguese	
Measurement method	According to IEEE Std C57, 12.90™ standard	
Power supply	Two rechargeable batteries: 12 V, NiMH, 1650 mAh	
Battery life	Up to 10 hrs in continuous operation, low-battery warning	
Battery charger	Universal input (90 to 264 Vrms), smart charger	
Charging time	< 4 hours for full charge	
Storage	10,000 tests	
Date / time	Power supplied by dedicated battery, real-time clock	
Communication	USB 2.0, optical isolation, 115.2 kB	
Software	Delivered with DataView® analytical software	
Dimensions / Weight	272 x 248 x 130 mm / 3.7 kg	
Connection	XLR connectors	
Leads	Screened H and X leads, length 4.6 m (15 ft), equipped with colour-coded crocodile clips	
Casing	Rugged polypropylene casing, UL 90 V0	
Vibrations	IEC 68-2-6 (1.5 mm at 55 Hz)	
Shocks	IEC 68-2-27 (30 G)	
Falls	IEC 68-2-32 (1 m)	
Protection rating	IP 40 with cover open as per EN 60529 IP 53 with cover closed as per EN 60529	
Safety	EN 61010-1, 50 V CAT IV; pollution degree 2	

State at delivery

DTR 8510 delivered with:

Delivered with a carrying bag containing 1 set of 4.6 m leads with crocodile clips, 1 external battery charger with mains power cable, 1 USB cable, 1 NiMH battery datasheet, 1 operating manual and DataView software on CD-Rom



Power analysers for three-phase networks

QUALI STAR+

- > 5 voltage inputs & 4 current inputs
- > Inrush mode over 10 minutes
- > Calculation of distorting power

1000 V CAT III **600 V CAT IV** **3U 4I** **4U 4I** **IP 53** **IEC 61000-4-30** **EN 50160**



	C.A 8331 P01160511	C.A 8333 P01160541	C.A 8336 P01160591
Reference	P01160511	P01160541	P01160591
Number of channels		3U / 4I	4U / 4I
Number of inputs		4V / 3I	5V / 4I
IEC 61000-4-30			EN50160 reports
Voltage (TRMS AC+DC)		2 V to 1,000 V	
Voltage ratio		Up to 500 kV	
Current (TRMS AC+DC)			
MN clamps		MN93: 500 mA to 200 Aac ; MN93A: 0.005 Aac to 100 Aac	
C193 clamps		1 A to 1,000 Aac	
AmpFlex® or MA clamps		100 mA to 10,000 Aac	
PAC93 clamp		1 A to 1,300 Aac/dc	
E3N clamp		50 mA to 100 Aac/dc	
Current ratio		Up to 60 kA	
Frequency		40 Hz to 69 Hz	
Power values		W (P), VA (S), var (N, Q ₁ , D), VAD, PF, DPF, cos φ, tan φ	
Energy values		Wh, varh (Nh, Q ₁ h, Dh), VAh	
Harmonics		Yes	
THD		Yes, from 0 to 50th order, phase	
Expert mode			Yes
Transients		50	210
Flicker (Pst and Plt)		Pst	Pst and Plt
Inrush mode		Yes on 4 periods	Yes > 10 minutes
Unbalance		Yes	
Recording	Min/Max	Yes	
of a selection of parameters at max. sampling rate	4 hrs to 2 weeks	A few days to several weeks	2 weeks to several years
Alarms		4,000 of 10 different types	10,000 of 40 different types
Peak		Yes	
Vectorial representation		Automatic	
Display		Colour ¼ VGA TFT screen, 320 x 240, diagonal 148 mm	
Capture of screens and curves		12	50
Electrical safety		IEC 61010 1 000 V CAT III / 600 V CAT IV	
Ingress protection		IP53 / IK08	
Languages		More than 27	
Battery life		Up to 13 hours	
Communication interface		USB	
Power supply		9.6 V NiMH rechargeable battery or mains power supply	
EN50160 report		Yes, with DataView® software	
Dimensions - Weight		240 x 180 x 55 mm - 1.9 kg	
Warranty		3 years	

State at delivery

• C.A 8336 • C.A 8333 - C.A 8331 - Models without sensors: Qualistar+ analyser delivered with a bag for accessories, 5 voltage cables 3 m long with 4 mm banana connections, 5 crocodile clips, a set of 12 coloured elements for identifying cables and inputs, an anti-scratch film to protect the screen (mounted), a USB cable, a mains power cable, a mains power pack, a safety datasheet, a CD containing a multilingual user's manual and a CD containing the PC data retrieval software (Power Analyzer Transfer).



Software

The measurements performed with the Qualistar models can be processed using two software products:

Power Analyzer Transfer (standard) and **DataView**® (option).



Power Analyzer Transfer

For transferring data onto a PC and communicating in real time via USB.

Supplied with the Qualistar+ models

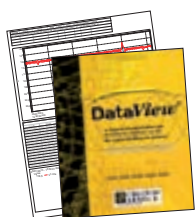

DataView®

Powerful configuration, transfer and measurement data processing software, with generation of reports according to the voltage quality standards as well as **EN5010** reports (C.A 8333/8230)

DataView® is compatible with other Chauvin Arnoux® products:

- C.A 8220 & C.A 8230 power analysers
- F407 and F607 multimeter clamps
- and other measuring instruments

Minimum required operating system: Windows® 7, 8 and 10.

Reference	P01102095
-----------	-----------

Complementary accessories

E3N adapter	P01102081
E3N mains power pack	P01120047
Battery pack	P01296024
Qualistar screen film	P01102059
Set of inserts and rings	P01102080
Set of 5 IP67 banana leads 3 m long (BB196)	P01295479
Bag no. 21	P01298055
Bag no. 22	P01298056
USB-A USB-B cable	P01295293
5 A casing	P01101959
Lockable crocodile clips (x 5)	P01102099
Kit comprising banana leads (x 5), crocodile clips (x 5) and a set of coloured rings	P01295483
Kit comprising banana leads (x 4), crocodile clips (x 4) and a set of coloured rings	P01295476
Set of plugs (C.A 8435)	P01102147
Mains power pack (C.A 8335)	P01102057

Accessories for all Qualistar+ models

Mains adapter

PA31ER adapter for 1,000 V power supply via the phase



Reference	P01102150
-----------	-----------

Storage tool

Reeling Box winder for stowing measurement cables



Reference	P01102149
-----------	-----------

Clamps for Qualistar+



	MA193 -250	MA193 -350	MA196 -350	A193 -450	A193 -800	A196 -450
Reference	P01120580	P01120567	P01120568	P01120526B	P01120531B	P01120554
Indice IP67	-	-	yes	-	-	yes
Measurement range	200 mA to 10 kAac					
Clamping Ø / length	Ø 70 mm / 250 mm	Ø 100 mm / 350 mm	Ø 100 mm / 350 mm	Ø 140 mm / 450 mm	Ø 250 mm / 800 mm	Ø 190 mm / 610 mm
IEC 61010	1,000 V CAT III / 600 V CAT IV					1,000 V CAT IV



	MN93	MN 93A	PAC93	C193	E3N	J93
Reference	P01120425B	P01120434B	P01120079B	P01120323B	P01120043A	P01120110
Measurement range	500 mA to 200 Aac	0,005 Aac to 100 Aac	1 A to 1,000 Aac 1 A to 1,300 Adc	1 A to 1,000 Aac	50 mA to 10 Aac/dc 100 mA to 100 Aac/dc	50 to 3,500 Aac 50 to 5,000 Adc
Clamping Ø	20 mm		1 x Ø 39 mm 2 x Ø 25 mm	52 mm	11.8 mm	72 mm
IEC 61010	600 V CAT III / 300 V CAT IV		600 V CAT III / 300 V CAT IV	600 V CAT IV	600 V CAT III / 300 V CAT IV	600 V CAT IV / 1,000 V CAT III



POWER, ENERGY, DISTURBANCES

Power and Energy Loggers

- > Single-phase, split-phase and three-phase installations
- > Installation without cutting off the mains power supply
- > Bluetooth, Ethernet and USB Communication
- > Automatic recognition of the sensors connected
- > Recording on SD card

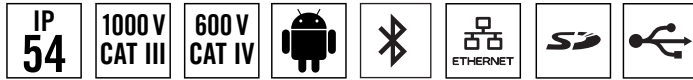

	PEL102 (without current sensors)	PEL103 (without current sensors)
Reference	P01157152	P01157153
Display	Without	With triple digital display
Installation types	Single-phase, split-phase, three-phase with or without neutral, and many other specific configurations	
Number of channels	3 Voltage inputs / 3 Current inputs (neutral current calculated)	
Measurements		
Network frequency	DC, 50 Hz, 60 Hz & 400 Hz	
Voltage (Measurement ranges/ Best accuracy)	10.00 to 1000 V _{AC/DC} / +/- 0.2 % + 0.5 V	
Current (depending on sensors) (measurement ranges / best accuracy)	from 5 mA _{AC} to 10 kA _{AC} / 50 mA _{DC} to 1,4 kA _{DC} / ±0.5 %	
Calculated measurements		
Ratios	Up to 650,000 V / up to 25,000 A	
Power	10 W to 10 GW / 10 var to 10 Gvar / 10 VA to 10 GVA	
Energy	Up to 4 EWh / 4 EVAh / 4 Evarh (E = 1018)	
Phase	cos φ, tan φ, PF	
Harmonics	Up to 50th order	
Additional functions		
Phase order	Yes	
Min / Max	Yes	
Mounting	Magnet, hook	
Recording		
Sampling / Acquisition rate / Aggregation	128 samples/period - 1 measurement/s – from 1 min to 60 min	
Storage	SD Card, 8 GB (SD-HC Card up to 32 GB)	
Communication	Ethernet & Bluetooth	
Power supply	110 V - 250 V (+10 %, -15 %) @ 50-60 Hz & 400 Hz	
Safety	IEC 61010 600 V CAT IV – 1,000 V CAT III	
Mechanical specifications		
Dimensions	256 x 125 x 37 mm without sensor	
Weight	900 g	950 g
Casing	IP54 , ETL	

Accessories

DataVIEW® software	P01102095
Bag No 23	P01298078
Leads/clamps kit	P01295476
Set of id. rings/inserts	P01102080
5 A box	P01101959
PEL100 mains adapter	P01102134
Mains power cable	P01295174
Reeling Box	P01102149

State at delivery

- **PEL102** and **PEL103**: 4 measurement leads (straight banana / straight banana – 3 m long – black), 4 crocodile clips (black), 1 SD card (8 GB), 1 set of rings and inserts (for ends of leads and current sensors), 1 mains cable, 1 USB cable (Type A / Type B), 1 operating manual (on CD), 1 bag, 1 safety datasheet, PEL Transfer PC software, 1 quick start-up guide, 1 SD MN adapter (depending on model).



PEL100 mains adapter
To self-power the PEL via the voltage measurement channel

Clamps for PEL



	MA193 -250	MA193 -350	MA196 -350	A193 -450	A193 -800	A196 -450
Reference	P01120580	P01120567	P01120568	P01120526B	P01120531B	P01120554
Indice IP67	-	-	yes	-	-	yes
Measurement range	200 mA to 10 kA _{AC}					
Clamping Ø / length	Ø 70 mm / 250 mm	Ø 100 mm / 350 mm	Ø 100 mm / 350 mm	Ø 140 mm / 450 mm	Ø 250 mm / 800 mm	Ø 190 mm / 610 mm
IEC 61010	1,000 V CAT III / 600 V CAT IV					1,000 V CAT IV



	MN93	MN 93A	PAC93	C193	E3N	J93
Reference	P01120425B	P01120434B	P01120079B	P01120323B	P01120043A	P01120110
Measurement range	500 mA to 200 A _{AC}	0,005 A _{AC} to 100 A _{AC}	1 A to 1,000 A _{AC} 1 A to 1,300 A _{DC}	1 A to 1,000 A _{AC}	50 mA to 10 A _{AC/DC} 100 mA to 100 A _{AC/DC}	50 to 3,500 A _{AC} 50 to 5,000 A _{DC}
Clamping Ø	20 mm		1 x Ø 39 mm 2 x Ø 25 mm	52 mm	11.8 mm	72 mm
IEC 61010	600 V CAT III / 300 V CAT IV		600 V CAT III / 300 V CAT IV	600 V CAT IV	600 V CAT III / 300 V CAT IV	600 V CAT IV / 1,000 V CAT III

Power and energy logger

- > Ideal for mounting on electricity poles
- > All-terrain shockproof casing resistant to UV light and high temperatures
- > Self-powered by its voltage inputs up to 1,000 V
- > Continuous recording at 200 ms intervals
- > Measurements in compliance with IEEE 1459



	PEL 105 P01157155
Reference	P01157155
Display	With backlit triple digital display
Type of installation	Single-phase, split-phase, three-phase with or without neutral and many other specific configurations
Number of inputs	5 voltage inputs, 4 current inputs
Number of channels	4 voltage channels, 4 current channels
Measurements	
Network frequency	DC, 50 Hz, 60 Hz and 400 Hz
Voltage (measurement ranges / best accuracy)	10.00 V to 1,000 VAC @ 50/60 Hz, or 600 VAC @ 400 Hz / 1,000 VDC
Current (depending on sensors) (measurement ranges / best accuracy)	5 mAAC to 10 kAAC / 50 mADC to 1.4 kADC
Calculated measurements	
Ratio	Up to 650,000 V / up to 25,000 A
Power	20 W to 10 GW / 20 var to 10 Gvar / 20 VA to 10 GVA
Energy	Up to 4 EWh / 4 EVAh / 4 Evarh (E = 1018)
Phase	cos ϕ , tan ϕ , PF
Phase sequence	Automatic selection of the phase sequence
Harmonics	Up to the 50th order
Additional functions	
Phase sequence	Indication of valid connection
Min / Max	On all quantities
Recording	
Sampling rate/ Acquisition rate / Aggregation	128 samples/period - 5 measurements/s - from 1 min to 1 hr
Storage	SD card, 8 GB (up to 32 GB with SD-HC card)
Communication	Ethernet, Bluetooth, Wifi and USB
Power supply	Self-powered internally from 94 to 1,000 V @ 50-60 Hz & 400 Hz / DC
Safety	IEC 61010 1,000 V CAT IV
Mechanical specifications	
Dimensions	245 x 270 x 180 mm
Weight	< 4 kg
Protection	IP 67

Clamps for PEL

see page 26

Reeling Box

for stowing the measurement leads of your PEL



Reference **P01102149**

State at delivery

PEL 105 delivered with:

- 5 x 3 m black silicone cables, straight banana / straight banana, 5 black 1,000 V CAT IV crocodile clips, 1 set of inserts/rings, 4 AmpFLEX® IP67 A196 3 m long, 1 set of waterproof plugs, 1 SD card, 1 USB cable, 1 bag, 1 safety datasheet, USB key containing 1 quick start-up guide and 1 user manual.

Accessories

Clamps for PEL - see page 24

Set of waterproof plugs	P01102147
Pole-mounting kit	P01102146
DataView® software	P01102095
Crocodile clips kit (x 5)	P01102099
Set of inserts/rings	P01102080
5 A adapter	P01101959
Leads kit (x 5) BB196	P01295479
Reeling Box	P01102149
E3N adapter	P01102081
PA30 mains power pack	P01102057

Oscilloscopes portables à voies isolées

600 V
CAT III

IP
54

HANDSCOPE

	OX 5022	OX 5042
Bandwidth	20 and 40 MHz	
Channels (number / type)	2 isolated	
IEC61010 safety	1 000V CAT II - 600V CAT III	
Analogue display or equivalent	No	
One-shot digital sampling rate	50 MS/s	
Repetitive mode	2 GS/s	
Vertical resolution	9 bits	
Transient detection (Glitch)	> 20ns	
Scaling / physical unit	•/•	
PC communication / Ethernet USB	•	
Mains power supply / Battery	•/•	
Integrated mode	Harmonics and multimeter	
"Oscilloscope" specifications		
Max. input sensitivity	5 mV/div	
Max. input amplitude	200 V/div	
Analogue filter	1.5 MHz, 5 kHz	
Time base (per division)	25 ns - 200 s	
Roll mode / XY mode	•/•	
Memory depth	2.5 k/channel	
Acquisition memory	2 MB memory	
No. of reference or math curves on screen	2	
Envelope / Averaging modes	•/•	
SPO (Smart Persistence Oscilloscope)	-	
Automatic measurements / cursors	19/•	
Calculation functions: + - / x / : / Advanced	•/•/•	
Autoset with channel selection	•	
Other functions		
TRMS multimeters	50 kHz	
Harmonic analysis	31 orders	
Threshold recorders (number of channels)	2	
Measurement of power / power harmonics	•	
General specifications		
Colour screen	3.5"	



State at delivery

Version C: 1 oscilloscope delivered with 1 probe (1/10, 1000 V), 1 BNC/Banana adapter, 1 set of banana leads, 1 mains adapter, 1 set of 6 AA NiMh batteries, 1 "hands-free" bag, 1 CD-Rom containing 1 operating manual and 1 programming manual

Version CK: same as version C plus 1 optical USB communication cable and 1 CD containing the SX-METRO/P software and USB cable drivers

References

- OX5022-C:** 1 oscilloscope 2 x 20 MHz
- OX5022-CK:** 1 oscilloscope, 2 x 20 MHz + USB communication
- OX5042-C:** 1 oscilloscope 2 x 40 MHz
- OX5042-CK:** 1 oscilloscope 2 x 40 MHz + USB communication

On-site oscilloscopes with isolated channels

Scopix IV - 5 instruments in 1:

- > oscilloscope
- > FFT
- > multimeter
- > logger & harmonic analyser
- > wattmeter



NEW

	OX 9062	OX 9102	OX 9104	OX 9304
Human-machine interface				
Type of display	7" WVGA TFT LCD colour touch screen, 800x480- LED backlighting (adjustable standby mode)			
Different display mode	2,500 real acquisition points on screen - Vectors with interpolation			
Display of curves on screen	4 curves + 4 references - Split Screen & Full Screen modes			
Screen commands	Touch screen - ANDROID-type icons and graphical commands - customizable channel colours			
Choice of language	15 complete languages, menus & online help			
Oscilloscope mode				
Vertical deflection				
Bandwidth	60 MHz	100 MHz	100 MHz	300 MHz
	Bandwidth limiter: 15 MHz, 1.5 MHz or 5 kHz			
Number of channels	2 isolated channels		4 isolated channels	
Input impedance	1 MΩ ± 0.5% , approx. 12 pF			
Maximum input voltage	600 V / CAT III (1,000 V with Probix) - 50 to 400 Hz - Probix safety connectors			
Vertical sensitivity	16 ranges from 2.5 mV-200 V/div and up to 156 μV/div in vertical zoom mode (12-bit converter) - Accuracy ± 2%			
Vertical zoom	"One Click Winzoom" system (12-bit converter and direct graphical zoom on screen) - x 16 max.			
Probe factors (non-Probix)	1 / 10 / 100 / 1,000 or any scaling - definition of measurement unit			
Horizontal deflection				
Sweep speed	35 ranges from 1 ns/div to 200 s/div., accuracy ± [50ppm +500ps] - Roll Mode from 100 ms to 200 s/div			
Horizontal zoom	"One Click Winzoom" system (direct graphical zoom on screen) x 1 to x 5 or x 100 - memory 100 kpts/channel			
Triggering				
Mode	On all channels: automatic, triggered, one-shot, auto level 50%			
Type	Edge, pulse width (16 ns-20 s), delay (48 ns to 20 s), counting (3 to 16,384 events) Continuous adjustment of Trigger position			
Coupling	AC, DC GND, HFR, LFR, noise - Level and Hold-Off adjustable from 64 ns to 15 s			
Sensitivity	≤ 1.2 divisions p-p up to 300 MHz			
Digital data storage				
Maximum sampling rate	2.5 GS/s in one-shot mode on each channel (max. 100 GS/s in ETS mode)			
Vertical resolution	12 bits (vertical resolution 0.025 %)			
Memory depth	100 kpts per channel and file viewer in the file manager			
User memory	Internal = 1 GB for file storage: trace, text, configuration, math functions, System memory: .pdf print files, .png image files			
File management	+ μSD-Removable 2 GB high-capacity SD card, SDHC 4-32 GB and SDXC > 32 GB			
GLITCH mode	Duration ≤ 2 ns - 500,000 Min/Max pairs			
Display modes	Envelope, vector, accumulation, averaging (factor 2 to 64) - XY (vector) and Y(f)=FFT			
Other functions				
AUTOSET	Complete in less than 5 s, with recognition of the channels - Frequency > 30 Hz			
FFT analyser & MATH functions	FFT (Lin or Log) on 2,500 pts with measurement cursors- + , - , x , / functions and mathematical function editor			
Cursors	2 or 3 cursors: V and T simultaneously with AUTO measurement: T1, T2, Dt, 1/Dt, dBV, Ph			
Automatic measurements	At the same time as the waveform, 20 automatic measurements per channel and on all 4 channels simultaneously with scrolling			
Multimeter mode				
General specifications	2 or 4 channels - 8 ,000 pts for min/max/frequency/relative - TRMS - Time/date-stamped graphical recording in Logger mode			
AC, DC and AC + DC voltages	600 mV to 600 VRMS, 800 mV to 800 VDC - accuracy VDC +/- (0.5 % + 25 D) - bandwidth 200 kHz			
Resistance	80 Ω to 32 MΩ - accuracy 0.5%R+ 25D - Quick bonding test < 10 ms			
Other measurements	Temperature (HX0035 = KTC, HX0036 = Pt100) / Capacitance 5 nF to 5 mF / Frequency 200 kHz / Diode test 3.3 V			
Single and three-phase power values	Active, Reactive and Apparent power values and Power Factor at the same times as the U & I measurements			
Harmonic analyser mode				
Multi-channel analysis	2 or 4 (depending on model), 63 orders, fundamental frequency from 40 to 450 Hz in auto or manual model			
Simultaneous measurements	Total Vrms, THD and selected order (% fundamental, phase, frequency, Vrms)			
Logger mode				
Acquisition	Duration: 20,000 s - Interval: 0.2 s - Files: 100,000 measurements			
General specifications				
Configuration memories	Not limited according to peripheral device - variable file sizes			
Printing	Network printer via Ethernet/Wifi in .png format			
PC communication - software link	Ethernet (100 baseT), Wifi-USB (device, 12 Mbs) - "ScopeNet" application software for PC			
Software	PC: Ethernet and et USB, ScopeNet (remote control, data retrieval, cursors and automatic measurements) Adapter / 2-hour fast charger, Universal 98-264 V / 50/60 Hz			
Main power supply	Li-Ion battery (6,900 mAh-40 Wh) - Battery life of up to 8 hrs - Adjustable standby mode			
Safety / EMC	Safety as per IEC 61010-2-30, 2010 - 600V CAT III / 1000 V CAT II - EMC as per EN 61326-1, 2010			
Mechanical specifications	292.5 x 210.6 x 66.2 mm - 2.1 kg with batteries - IP54 protection			
Reference to order	OX9062	OX9102	OX9104	OX9304

SCOPIX IV state at delivery







1 SCOPIX IV oscilloscope delivered with a carrying bag, a PA40W-2 mains power pack/charger and a 2P EURO mains power cable, Li-ion battery pack, 1 stylus, 1 Ethernet cable, 1 USB cable, 2 safety leads (red, black), 2x Ø 4 mm test probes (red, black), 2 or 4 voltage probes depending on model, 1 μSD card (8 GB), 1 USB/ μSD adapter, 1 wrist strap, 1 PROBIX BANANA, 1 USB installation procedure for use of ScopeNet data export software on CD-ROM, 1 .pdf user's manual on CD (>5 languages), 1 startup guide on paper and 1 safety datasheet in 20 languages.

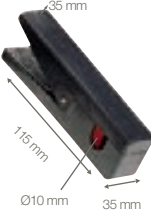
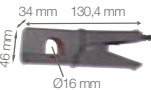

CURRENT MEASUREMENT

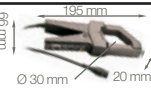
AC and AC/DC current measurement



	Series	Model	Input ⁽¹⁾						Output / Connections			Specific features					To order				
			Very low current	Low current	Medium current	High current	~ AC	DC	Current	Voltage	Leads + safety plug ø 4 mm ⁽²⁾	Female sockets ø 4 mm	BNC connector (oscilloscope)	Transformation ratio (input/output)	Output protected against overvoltage	Automatic DC zero		Power measurement (low phase shift)	Bandwidth (frequency in Hz)	Typical accuracy	
AC	 <p>35 mm 115 mm Ø10 mm 35 mm</p>	MINI 01		2 to 150 A					●			0.15 A AC			1,000/1	●			48 Hz... 500 Hz	≤ 2.5 %	P01051101Z
		MINI 02	50 mA to 100 A						●			0.1 A AC			1,000/1	●	●		48 Hz... 10 kHz	≤ 1 %	P01051102Z
		MINI 03		1 to 100 A					●			0.1 V AC			1 A / 1 mV					≤ 2 %	P01051103Z
		MINI 05		5 mA to 10 A 1 to 100 A					●			10 V A AC 0.1 V AC			1 mA/1 mV 1 A/1 mV				48 Hz... 500 Hz	≤ 3 % ≤ 2 %	P01051105Z
		MINI 09		1 to 150 A					●			15 V DC			1 A/100 mV					≤ 4 %	P01051109Z
	 <p>34 mm 130,4 mm 46 mm Ø16 mm</p>	MINI 102		0.05 A - 200 A					●			0.2 A ac			1,000/1				48 Hz... 10 kHz	≤ 1 %	P01106102
		MINI 103		0.1 A - 200 A					●			0.2 V AC			1 A / 1 mV				48 Hz... 10 kHz	≤ 1.5 %	P01106103
	 <p>18,5 mm Ø21 mm 136 mm 57 mm</p>	MN08		0.5 to 240 A					●			0.2 A AC			1,000/1				40 Hz... 10 kHz	≤ 1 %	P01120401
		MN09		0.5 to 240 A					●			0.2 A AC			1,000/1				40 Hz... 10 kHz	≤ 1 %	P01120402
		MN11		0.5 to 240 A					●			0.2 A AC			1,000/1	●			40 Hz... 10 kHz	≤ 2 %	P01120404
		MN12		0.5 to 240 A					●			2 V AC		●	1 A/10 mV				40 Hz... 10 kHz	≤ 1 %	P01120405
		MN13		0.5 to 240 A					●			2 V AC		●	1 A/10 mV				40 Hz... 10 kHz	≤ 1 %	P01120406
		MN14		0.5 to 240 A					●			0.2 V AC		●	1 A/1 mV				40 Hz... 10 kHz	≤ 1 %	P01120416
		MN39		0.1 to 24 A 0.5 to 240 A					●			2 V AC 2 V AC		●	1 A/100 mV 1 A/10 mV				40 Hz... 10 kHz	≤ 1 %	P01120408
		MN73		10 mA to 2.4 A 100 mA to 240 A					●			2 V AC 2 V AC		●	1 mA/1 mV 1 A/10 mV				40 Hz... 10 kHz	≤ 1 % ≤ 2 %	P01120421
MN89			0.5 to 240 A					●			20 V DC ⁽³⁾		●	1 A/100 mV				40 Hz... 10 kHz	≤ 2 %	P01120415	
 <p>139 mm Ø30 mm 20 mm</p>	Y1N		4 A to 600 A					●			0.5 A AC			1,000/1	●			48 Hz... 1 kHz	≤ 3 %	P01120001A	
	 <p>Ø101 mm 216 mm 31 mm 99 mm</p>	C100		0.1 A to 1,200 A					●		1 A AC			1,000/1				30 Hz... 10 kHz	≤ 0.5 %	P01120301	
		C103		0.1 A to 1,200 A					●			1 A AC			1,000/1	●			30 Hz... 10 kHz	≤ 0.5 %	P01120303
		C122		1 A to 1,200 A					●			5 A AC			1,000/5	●			30 Hz... 10 kHz	≤ 1 %	P01120306
		C148		1 to 300 A 1 to 600 A 1 to 1,200 A					●			5 A AC			250/5 500/5 1,000/5	●			48 Hz... 1 kHz	≤ 2 % ≤ 1 % ≤ 1 %	P01120307
		C173		1 mA to 1.2 A 0.01 to 12 A 0.1 to 120 A 1 to 1,200 A					●			1 V AC			1 A/1 V 10 A/1 V 100 A/1 V 1,000 A/1 V				10 Hz... 3 kHz	≤ 0.7 % ≤ 0.5 % ≤ 0.3 % ≤ 0.2 %	P01120309
 <p>49 mm Ø64 mm 310 mm 310 mm</p>	D30CN		1 to 3,600 A					●			1 A AC			3,000/1	●	●		30 Hz... 5 kHz	≤ 0.5 %	P01120064	
	D36N		1 to 3,600 A					●			3 A AC			3,000/3	●	●		30 Hz... 5 kHz	≤ 0.5 %	P01120055A	
AC/DC	 <p>11 mm 15 mm Ø3,9 mm 25 mm</p>	K1		1 mA to 4.5 A DC 1 mA to 3 A RMS 1 mA to 4.5 A peak				●	●		4.5 V DC 3 V RMS 4.5 V peak			1 mA/1 mV				DC... 2 kHz	≤ 1 %	P01120067A	
		K2		100 µA to 450 mA DC 100 µA to 300 mA RMS 100 µA to 450 A peak				●	●			4.5 V DC 3 V RMS 4.5 V peak			1 mA/10 mV				DC... 1.5 kHz	≤ 1 %	P01120074A
	 <p>67 mm 231 mm Ø11,8 mm 20 mm</p>	E1N		0.05 to 2 A DC 0.05 to 1.5 A AC 0.5 to 150 A AC/DC					●	●		2 V DC 1.5 V AC 150 mV AC/DC			1 A/1 V 1 A/1 mV				DC... 2 kHz DC... 8 kHz	≤ 2 % ≤ 1.5 %	P01120030A
		E6N		5 mA to 2 A DC 5 mA to 1.5 A AC 20 mA to 80 A AC/DC					●	●		2 V AC 1.5 V AC 0.8 V AC/DC			1 A/1 V 1 A/10 mV				DC... 2 kHz DC... 8 kHz	≤ 2 % ≤ 4 %	P01120040A

(1) The higher value corresponds to 120% of the max. rated value (2) Reshaping of AC signal by diodes (3) Lead + electronic unit with Ø 4 mm safety plugs, 19 mm spacing, for K series

AC/DC current measurement



AC/DC	Series	Model	Input ⁽¹⁾						Output / Connections				Specific features				To order	
			• Very low current	• Low current	• Medium current	• High current	• ~ AC	• DC	• Current	• Voltage	• Leads + safety plug ø 4 mm ⁽²⁾	• Female sockets ø 4 mm	• BNC connector (oscilloscope)	• Transformation ratio (input/output)	• Output protected against overvoltage	• Automatic DC zero		• Bandwidth (frequency in Hz)
		PAC10	0.5 to 400 A AC 0.5 to 600 A DC				•	•		600 mV AC/DC	•		1A/1mV			DC... 5 kHz	≤ 2%	P01120070
		PAC11	0.2 to 40 A AC 0.4 to 60 A AC 0.5 to 400 A AC 0.5 to 600 A DC				•	•		600 mV AC/DC	•		1A/10mV 1A/1mV	•		DC... 10 kHz	≤ 1.5% ≤ 2%	P01120068
		PAC20	0.5 to 1,000 A AC 0.5 to 1,400 A DC				•	•		1.4 V AC/DC	•		1A/1mV			DC... 5 kHz	≤ 2%	P01120071
		PAC21	0.2 to 100 A AC 0.4 to 150 A DC 0.5 to 1,000 A AC 0.5 to 1,400 A DC				•	•		1.4 V AC/DC	•		1A/10mV 1A/1mV	•		DC... 10 kHz	≤ 1.5% ≤ 2.5%	P01120069

(1) The higher value corresponds to 120% of the max. rated value (2) Lead + electronic housing with Ø 4 mm safety plugs, centre distance 19 mm, for K series.

Measurement on oscilloscope

	Series	Model	Input						Output / Connections				Specific features				To order		
			Measurement range ⁽¹⁾						• Current	• Voltage	• Leads + safety plug ø 4 mm ⁽²⁾	• Female sockets ø 4 mm	• BNC connector (oscilloscope)	• Transformation ratio (input/output)	• Output protected against overvoltage	• Automatic DC zero		• Power measurement (low phase shift)	• Bandwidth (frequency in Hz)
AC		MN60	0.1 A to 60 A peak 0.5 A to 600 A peak				•										6 V peak		
		Y7N	1 A to 1,200 A peak				•		1.2 V peak			•	1 mA / 1 mV				5 Hz to 10 kHz	≤ 2%	P01120075
		C160	0.1 A to 30 A peak 1 A to 300 A peak 1 A to 2,000 A peak				•		3 V peak 3 V peak 2 V peak			•	10 A / 1 V 100 A / 1 V 1,000 A / 1 V				10 Hz to 100 kHz	≤ 3% ≤ 2% ≤ 1%	P01120308
		D38N	1 A to 90 A peak 1 A to 900 A peak 1 A to 9,000 A peak				•		10 V A AC 0.1 V AC			•	1 A / 10 V 1 A / 1 mV 1 A / 0.1 mV				30 Hz to 50 kHz	≤ 2%	P01120057A
		MA200 30-300/3 (17 cm)	0.5 A ... 45 A peak 0.5 A ... 450 A peak				•		4.5 V peak			•	100 mV/A 10 mV/A				5 Hz to 1 MHz please shift at 1 kHz ≤ 1.5°	≤ 1% +0.3 A	P01120570
		MA200 30-300/3 (25 cm)	0.5 A ... 45 A peak 0.5 A ... 450 A peak				•		4.5 V peak			•	100 mV/A 10 mV/A				5 Hz to 1 MHz please shift at 1 kHz ≤ 1.5°	≤ 1% +0.3 A	P01120571
	MA200 30-300/3 (35 cm)	5 A ... 4,500 A peak				•		4.5 V peak			•	1 mV/A				5 Hz to 1 MHz please shift at 1 kHz ≤ 1.5°	≤ 1% +0.3 A	P01120572	
AC/DC		E3N	0.05 A to 10 A peak 1 A to 100 A peak				•	•	1 V peak			•	1 A / 10 mV 1 A / 1 mV				DC to 100 kHz	≤ 3% ≤ 4%	P01120043A
		PAC12	0.2 A to 60 A peak 0.4 A to 60 A DC 0.5 A to 600 A peak 0.5 A to 600 A DC				•	•	600 mV peak			•	1 A / 10 mV 1 A / 1 mV	•			DC to 10 kHz	≤ 1.5% ≤ 2%	P01120072
		PAC22	0.2 A to 150 A peak 0.4 A to 150 A DC 0.5 A to 1,400 A peak 0.5 A to 1,400 A DC				•	•	1.4 V peak			•	1 A / 10 mV 1 A / 1 mV	•			DC to 10 kHz	≤ 1.5% ≤ 2.5%	P01120073
		MH60	0.01 A - 140A peak				•	•	1.4 V peak			•	10 mV/A	•			DC to 1 MHz	≤ 1.5%	P01120612

(1) The higher value corresponds to 120% of the max. rated value (2) Lead + electronic unit with Ø 4 mm safety plugs with 19 mm spacing for the AmpFLEX series



CURRENT MEASUREMENT

AC current measurement

MA400D, MA 4000D

600 V CAT IV	TRMS	20 mA	MAX Hold
-----------------	------	-------	-------------

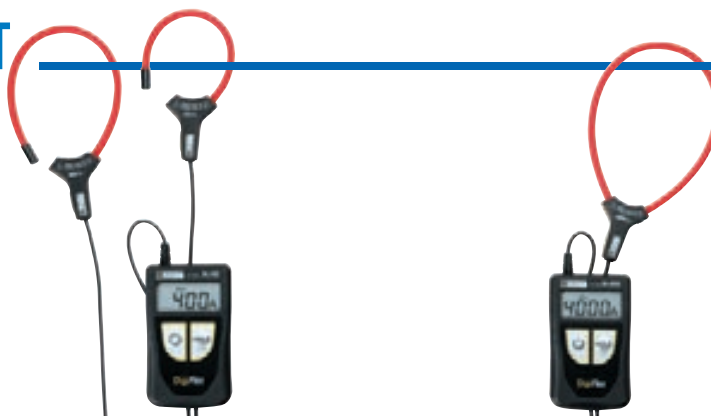

	MA400D-170 / MA400D-250			MA4000D-350		
References	P01120575Z / P01120567Z			P01120577Z		
Display range	4 A AC	40 A AC	400 A AC	40 A AC	400 A AC	4,000 A AC
Measurement range	0.020 A... 3.999 A	4.00 A... 39.99 A	40.0 A... 399.9 A	0.01 A... 39.99 A	40.0 A... 399.9 A	400 A... 3,999 A
Resolution	1 mA	10 mA	100 mA	10 mA	100 mA	1 A
Accuracy	± (2 % + 10 cts)	± (1.5 % + 2 cts)	± (1.5 % + 2 cts)	± (2 % + 10 cts)	± (1.5 % + 2 cts)	± (1.5 % + 2 cts)
Sensor clamping diam. / length	MA400D-170: Ø 45 mm / 170 mm MA400D-250: Ø 70 mm / 250 mm			MA4000D-350: Ø 100 mm / 350 mm		
Bandwidth	10 Hz ... 3 kHz					
Power supply	2 x 1.5 V AAA/LR3 batteries					
Safety	IEC 61010 CAT IV 600V					
Operating temperature	0°C to +50°C					
Instrument weight	Approx. 130 g					
Casing dimensions	100 x 60 x 20 mm					
Length of connection cable	0.8 m					

State at Delivery

1 DigiFLEX sensor delivered in a blister pack with 2 x 1.5V AAA batteries,
1 elastic strap and an operating manual in 5 languages

Accessories & Replacement Parts

Bag 120 x 200 x 60	P01298074
MULTIFIX accessories	P01102100Z
Elastic strap	P01102113

AmpFlex® flexible probes for AC current

1000 V CAT IV	80 mA	30000 A AC	IP 67	4 calibres
------------------	-------	------------	----------	---------------

Other dimensions:
contact us

A110,
A130

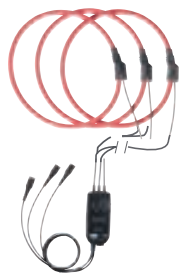

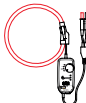
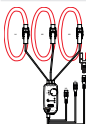
Series	Model	Input						Output - Connections				Specific features					Reference	
		Very low current	Low current	Medium current	High current	Alternating current	Direct current	Current	Voltage	Lead + safety sockets ø 4 mm	Female sockets ø 4 mm	BNC connector (coaxial)	Transformation ratio (input/output)	Output protected against overvoltages	Automatic DC zero	Power measurement (low phase shift)		Bandwidth (frequency in Hz)
	A110 3-30-300-3000/3 (45 cm / Ø 14 cm)	0.08 A - 3 A 0.5 A .. 30 A 0.5 A .. 300 A 0.5 A .. 3,000 A						3 V AC				1 V/A 100 mV/A 10 mV/A 1 mV/A				10 Hz .. 10 kHz 10 Hz .. 20 kHz 10 Hz .. 20 kHz 10 Hz .. 20 kHz	≤ 1%	P01120630
	A110 3-30-300-3000/3 (80 cm / Ø 25 cm)	0.08 A - 3 A 0.5 A .. 30 A 0.5 A .. 300 A 0.5 A .. 3,000 A						3 V AC				1 V/A 100 mV/A 10 mV/A 1 mV/A				10 Hz .. 10 kHz 10 Hz .. 20 kHz 10 Hz .. 20 kHz 10 Hz .. 20 kHz	≤ 1%	P01120631
	A110 30-300-3000-30000/3 (120 cm / Ø 38 cm)	0.05 A - 30 A 0.5 A .. 300 A 0.5 A .. 3000 A 0.5 A .. 30,000 A						3 V AC				100 mV/A 10 mV/A 1 mV/A 0,1 mV/A				10 Hz .. 5 kHz 10 Hz .. 20 kHz 10 Hz .. 20 kHz 10 Hz .. 20 kHz	≤ 1%	P01120632
	A130 30-300-3000/3 (80 cm / Ø 25 cm)	0.5 A .. 30 A 0.5 A .. 300 A 0.5 A .. 3,000 A						3 V AC				100 mV/A 10 mV/A 1 mV/A				10 Hz .. 20 kHz 10 Hz .. 20 kHz 10 Hz .. 20 kHz	≤ 1%	P01120633

MiniFlex® flexible probes for AC current

MA110, MA130

600 V CAT IV	1000 V CAT III	80 mA	3000 A _{AC}	4 calibres	IP 67
-----------------	-------------------	-------	----------------------	---------------	----------



MA200

600 V CAT IV	1000 V CAT III	1 MHz
-----------------	-------------------	-------



MA110 model



Measurement from 20 mA.
Can be connected to the AC voltage input (mVAC / VAC) of any multimeter or measuring instrument equipped with Ø 4 mm female banana plugs.

Three-phase MA130 model

Can be connected to the AC voltage inputs (mVAC / VAC) of any power analyser, logger or measuring instrument equipped with BNC plugs.

MA200 model

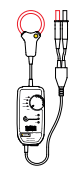
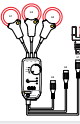
Equipped with a BNC output and can be connected to all types of oscilloscopes. Offers high bandwidth.

Series	Model	Input						Output - Connections			Specific features					Reference		
		Measurement range						Current	Voltage	Lead + safety plugs ø 4 mm	Female sockets ø 4 mm	BNC connector (coaxial)	Transformation ratio (input/output)	Output protected against overvoltages	Automatic DC zero		Power measurement (low phase shift)	Bandwidth (frequency in Hz)
Very low current	Low current	Medium current	High current	Alternating current	Direct current													
	MA110 3-30-300-3000/3 (17 cm / Ø 4,5 cm)	0.08 A - 3 A 0.5 A .. 30 A 0.5 A .. 300 A 0.5 A .. 3,000 A						3 VAC				1 V/A 100 mV/A 10 mV/A 1 mV/A				10 Hz .. 10 kHz 10 Hz .. 20 kHz 10 Hz .. 20 kHz 10 Hz .. 20 kHz	≤ 1%	P01120660
	MA110 3-30-300-3000/3 (25 cm / Ø 7 cm)	0.08 A - 3 A 0.5 A .. 30 A 0.5 A .. 300 A 0.5 A .. 3,000 A						3 VAC				1 V/A 100 mV/A 10 mV/A 1 mV/A				10 Hz .. 10 kHz 10 Hz .. 20 kHz 10 Hz .. 20 kHz 10 Hz .. 20 kHz	≤ 1%	P01120661
	MA110 3-30-300-3000/3 (35 cm / Ø 10 cm)	0.08 A - 3 A 0.5 A .. 30 A 0.5 A .. 300 A 0.5 A .. 3,000 A						3 VAC				1 V/A 100 mV/A 10 mV/A 1 mV/A				10 Hz .. 10 kHz 10 Hz .. 20 kHz 10 Hz .. 20 kHz 10 Hz .. 20 kHz	≤ 1%	P01120662
	MA130 30-300-3000/3 (25 cm / Ø 7 cm)		0.5 A .. 30 A 0.5 A .. 300 A 0.5 A .. 3,000 A					3 VAC				100 mV/A 10 mV/A 1 mV/A				10 Hz .. 20 kHz 10 Hz .. 20 kHz 10 Hz .. 20 kHz	≤ 1%	P01120663
	MA200 30-300/3 (17 cm / Ø 4,5 cm)		0.5 A...45 A _{PEAK} 0.5 A...450 A _{PEAK}					4,5 V _{PEAK}				100 mV/A 10 mV/A					≤ 1% + 0,3 A	P01120570
	MA200 30-300/3 (25 cm / Ø 7 cm)		0.5 A...45 A _{PEAK} 0.5 A...450 A _{PEAK}					4,5 V _{PEAK}				100 mV/A 10 mV/A			5 Hz...1 MHz		≤ 1% + 0,3 A	P01120571
	MA200 3000 /3 (35 cm / Ø 10 cm)		5 A...4,500 A _{PEAK}					4,5 V _{PEAK}				1 mV/A					≤ 1% + 0,3 A	P01120572

Power quality & installation supervision

Functions

- > Configuration of all the functions of instruments connected to a PC or via Bluetooth
- > Recovery of the recorded measurement data
- > Backup of measurement files
- > Opening of saved files
- > Processing and creation of reports (EN50160)
- > Export into an Excel spreadsheet
- > Export in .pdf format
- > Database management

Additional info

The DataView® software

- > Automatically recognizes the instrument connected when it is connected to the PC and opens the corresponding menu. Users then have direct access to the configuration and to the saved data
- > Includes a large number of predefined report templates for quick generation in compliance with the applicable standards. Users can create their own models to fit their needs and add their own comments directly



Scan this code to find out more about DataView's performance features



Reference	P01102095
-----------	-----------

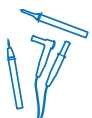

TEST AND MEASUREMENT ACCESSORIES

Selection of Chauvin Arnoux accessories

- > Ø 4 mm banana connection accessories
- > Temperature measurement
- > Electrical installation testing
- > Protection, storage and transport

Scan this code to find out more about the selection of Chauvin Arnoux accessories



... by function

A	
AC current miniclamps	p.30
Accessories:	
• Ø 4 mm banana connectors	p.32-33
• transport (soft cases, hard cases, bags)	p.34
• protection (soft cases, hard cases, bags)	p.34
AmpFlex® clamps	p.29
AmpFlex®	p.32
ASYC IV digital multimeters	p.07
C	
Cable locator	p.21
Clamps:	
• AC current clamps	p.25/26/31
• AC/DC current clamps	p.25/31
• digital clamp multimeters	p.04/05
• earth and loop tester clamps	p.25
CO ₂ / Temperature / Humidity measurement	p.10
Contact thermometers	p.9

D	
DataView® software	p.16/25/34
Digital ammeters with flexible sensors	p.32
Digital insulation testers	p.16-17
Digital testers	p.8
E	
Earth and resistivity kit	p.18
Earth and resistivity testers	p.18
Earth and resistivity testers with adapter for pylon earth measurements	p.19
F	
Flexible current sensors	p.31/33
I	
Installation testers	p.13
Insulation and bonding testers	p.14-15
L	
LED voltage tester	p.8
Luxmeters	p.11

M	
Megohmmeters	(see Insulation Testers)
Micro-ohmmeters	p.22
O	
On-site digital oscilloscopes	p.28/29
P	
Power Analyser Transfer software	p.25
Power analysers for three-phase networks	p.24-25
Power and energy loggers	p.26-27
R	
Ratiometer	p.23
Reeling box	p.25
T	
Testers	p.8
Thermal cameras	p.36
Thermo-anemometers	p.11
Thermo-hygrometers	p.10
TRMS digital multimeters	p.06

... by product

A		
A110/130	Flexible current sensors	p.32
A193-450/A193-800	AmpFlex® clamps	p.25/26
A196	AmpFlex® clamps	p.25/26
AmpFlex®	Flexible current sensors	p.32
B		
Banana	connection accessories Ø 4 mm	p. 34-35
C		
C100 to C173 AC	current clamps	p.30-31
C193 AC	current clamp	p.25/26
C.A 1110	Luxmeters	p.11
C.A 1227	Thermo-anemometers	p.11
C.A 1246	Thermo-hygrometers	p.10
C.A 1510	CO ₂ , temperature and humidity loggers	p.10
C.A 1821/1822/1823	Logger contact thermometers	p.09
C.A 1950/1954	Thermal camera	p.36
C.A 5273/5275/5277	TRMS multimeters	p.06
C.A 6116N/6117	Installation testers	p.13
C.A 6240/6250	Micro-ohmmeters	p.22
C.A 6292	Micro-ohmmeters	p.22
C.A 6416/6417	Earth and loop tester clamps	p.20
C.A 6460/6462/6470N/6471	Earth and resistivity testers	p.18
C.A 6472/6474	Earth and resistivity testers with adapter for pylon earth measurements	p.19
C.A 6505	Digital insulation tester	p.21
C.A 6532/6534/6536	Insulation and bonding testers	p.14-15
C.A 6541/6543/6545/6547/6549	Digital insulation testers	p.16
C.A 6550/6555	Digital insulation testers	p.17
C.A 6681	Cable locator	p.21
C.A 755/ 757	Digital testers	p.08
C.A 8331/8333/8336	Power analysers for three-phase networks	p.24-25
D		
DataView®	software	p.16/25/34
D30CN / D36N	AC current clamps	p.32
D38N	AC current clamp	p.33
DTR 8510	Single-phase ratiometer	p.23

E		
E1N/E6N	AC/DC current clamps	p.30
E3N	AC/DC current clamp	p.26/31
Earth and resistivity kit		p.18
F		
F201/203/205	Digital clamp multimeters	p.04-05
F401/403/405/F407	Digital clamp multimeters	p.04-05
F603/605/F607	Digital clamp multimeters	p.04-05
J		
J93	AC/DC current clamp	p.25/26
K		
K1/ K2	AC/DC current clamps	p.30
M		
MA 100	Flexible current sensors	p.33
MA193	AC current clamps	p.25/26
MA 200	Flexible current sensors	p.31/33
MA400D/MA4000D	Flexible current sensors	p.32
MINI 01/02/03/05/09/102/103	AC current miniclamps	p.30
MN60	AC current clamp	p.31
MN 08 to MN 89	AC current clamps	p.30
MN93/93A	AC current clamps	p.25/26
MTX 203	TRMS digital multimeters	p.06
MTX 3290/3291/3292/3293	Digital multimeters	p.07
O		
OX 5022/5042	On-site digital oscilloscopes	p.28
OX 9062/9102/9104/9304	On-site oscilloscopes	p.29
P		
PAC10/11/12	AC/DC current clamps	p.31
PAC20/21/22	AC/DC current clamps	p.31
PAC93	AC/DC current clamps	p.25
PEL 102/103/105	Power and energy loggers	p.26-27
Power Analyser Transfer	software	p.25
R		
Reeling Box	cable winder	p.25
T		
Transport and protection accessories		p.34
TX01	LED voltage tester	p.08
Y		
Y1N	AC current clamp	p.30
Y7N	AC current clamp	p.31



ENVIRONMENTAL MEASUREMENTS

C.A 1954
COMMERCIALIZATION
IN 2018

Discover
our thermal
cameras!



	C.A 1950	C.A 1954
Reference	P01651901	P01651904
Detector	80 x 80	120 x 160
Sensitivity (NETD)	80 mK @ 30 °C (0.08 °C @ 30 °C)	
Temperature range	-20 °C to +250 °C	
Accuracy	±2 °C or ±2 % of reading	
Field of view	20° x 20°	28° x 38°
IFOV (spatial resolution)	4.4 mrad	4.1 mrad
Focus	Fixed	
Real image	Yes	
Measurement tools	1 manual cursor, automatic Min/Max detection, temperature profile, Isotherm	
Parameter settings	Emissivity, environmental temperature, distance, relative humidity	
Voice comments	Yes via Bluetooth (earpiece supplied)	
Connectivity	F407, F607, MTX 3292 & MTX 3293 clamps, environmental measurement products (C.A 1821, C.A 1822, C.A 1823, C.A 1246)	
Data storage	On 2 GB micro SD card (approx. 4,000 images), up to 32 GB on removable card	
Battery life	13 hrs 30 min	9 hrs
Type	NiMH rechargeable batteries with low self-discharge or alkaline batteries	
Ingress protection	IP 54	
Resistance	Fall from 2 metres	
Dimensions and weight	225 x 125 x 83 / 700g with rechargeable batteries	

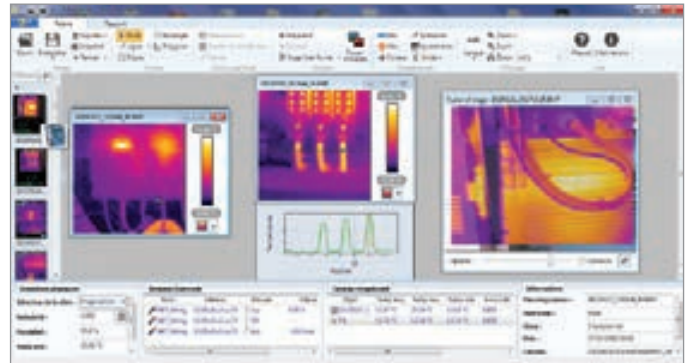

CAM Report software

The CAMReport software is equipped with a very simple user interface for:

- Analysis of the thermograms
- Recovery of the voice comments or connected measurements
- Automatic merging of the thermal and real images recorded simultaneously
- Automatic report generation for export in .pdf or .docx format.



State at delivery

Cameras delivered in hard site case with 4 NiMH batteries and a battery charger, 1 micro SD HD card, 1 USB cable, 1 Bluetooth earpiece, CAMReport software on CD ROM, user's manuals and a measurement report.

906 131100 - Ed. 11 - 2018 - Non-contractual document. Photos: Chauvin Arnoux Group. Please confirm specifications when ordering.



Chauvin Arnoux International

190, rue Championnet
75876 Paris Cedex 18 - FRANCE
export@chauvin-arnoux.fr
www.chauvin-arnoux.com
tel: +33 1 44 85 44 38
fax: +33 1 46 27 95 59